

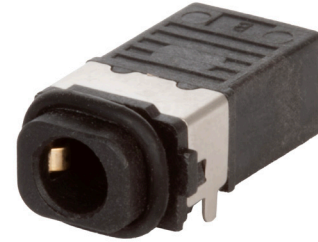

**MODEL:** SJ3-350144A-TR-X7 | **DESCRIPTION:** AUDIO JACK

**FEATURES**

- reflow solder
- IPX7



**SPECIFICATIONS**

parameter	conditions/description	min	typ	max	units
rated input voltage			30		Vdc
rated input current				0.5	A
contact resistance				100	mΩ
insulation resistance	at 500 Vdc	100			MΩ
voltage withstand	for 1 minute			500	Vac
operating temperature		-20		70	°C
storage temperature		-40		85	°C
life			5,000		cycles
flammability rating	UL94V-0				
RoHS	yes				
IP level	IPX7				

**SOLDERABILITY**

parameter	conditions/description	min	typ	max	units
reel storage	5~35°C, <75% humidity				°C
reflow soldering	see reflow profile			260	°C
drying conditions	bake at 120°C for 4 hours				

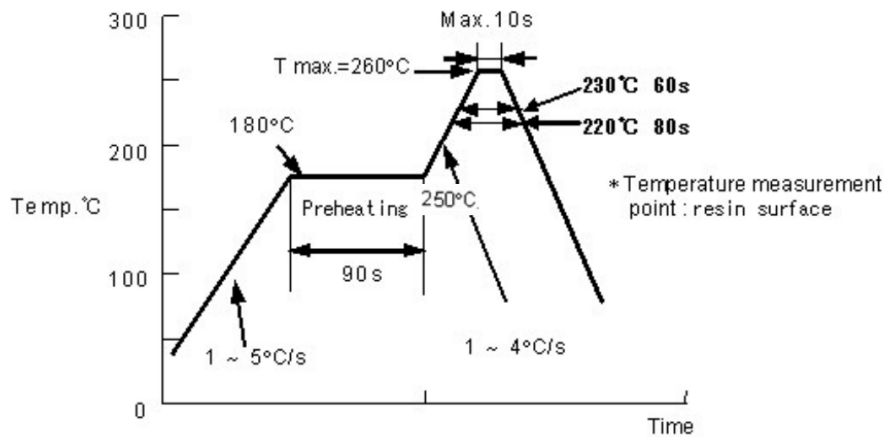

## MECHANICAL DRAWING

units: mm  
 tolerance:  
 X.X ±0.50 mm  
 X.XX ±0.30 mm  
 X.XXX ±0.15 mm  
 PCB: ±0.05 mm  
 unless otherwise specified  
 PCB thickness: 0.80 mm

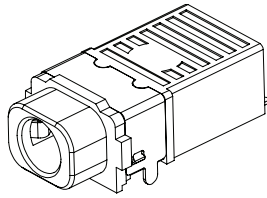

ITEM	DESCRIPTION	MATERIAL	PLATING/COLOR
1	housing	PA10T [UL94V-0]	black
2	cover	PA10T [UL94V-0]	black
3	shield	C5191	nickel
4	terminal 1	C5210	gold flash
5	terminal 2	C5210	gold flash
6	terminal 3	C5210	gold flash
7	terminal 4	C5210	gold flash
8	terminal 5	C5210	gold flash

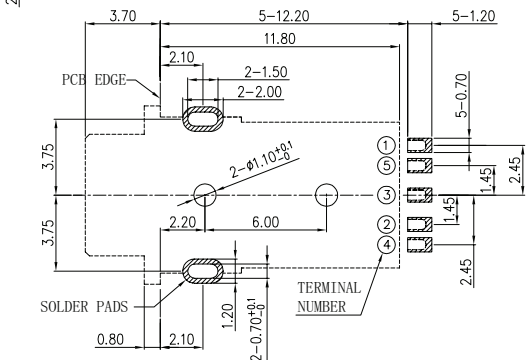
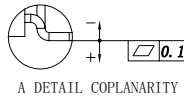
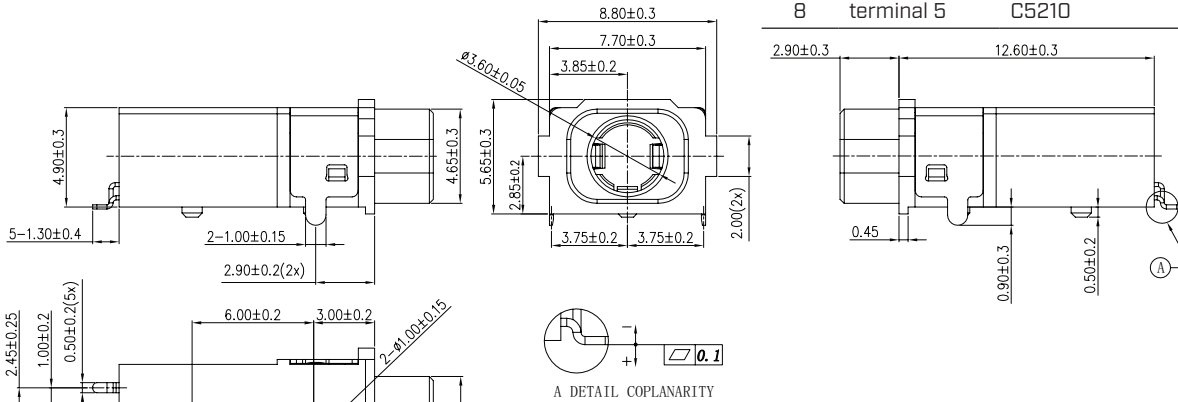

Recommended PCB Layout  
Top View

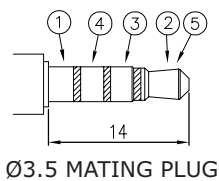
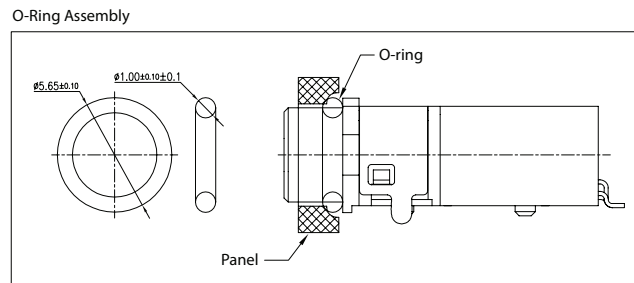

Model No.	SJ3-350144A-TR-X7
Schematic	
PIN	
1	sleeve
2	tip
3	ring 1
4	ring 2
5	tip

## PACKAGING

units: mm

Reel Size:  $\varnothing 330$  mm

Reel QTY: 800 pcs per reel

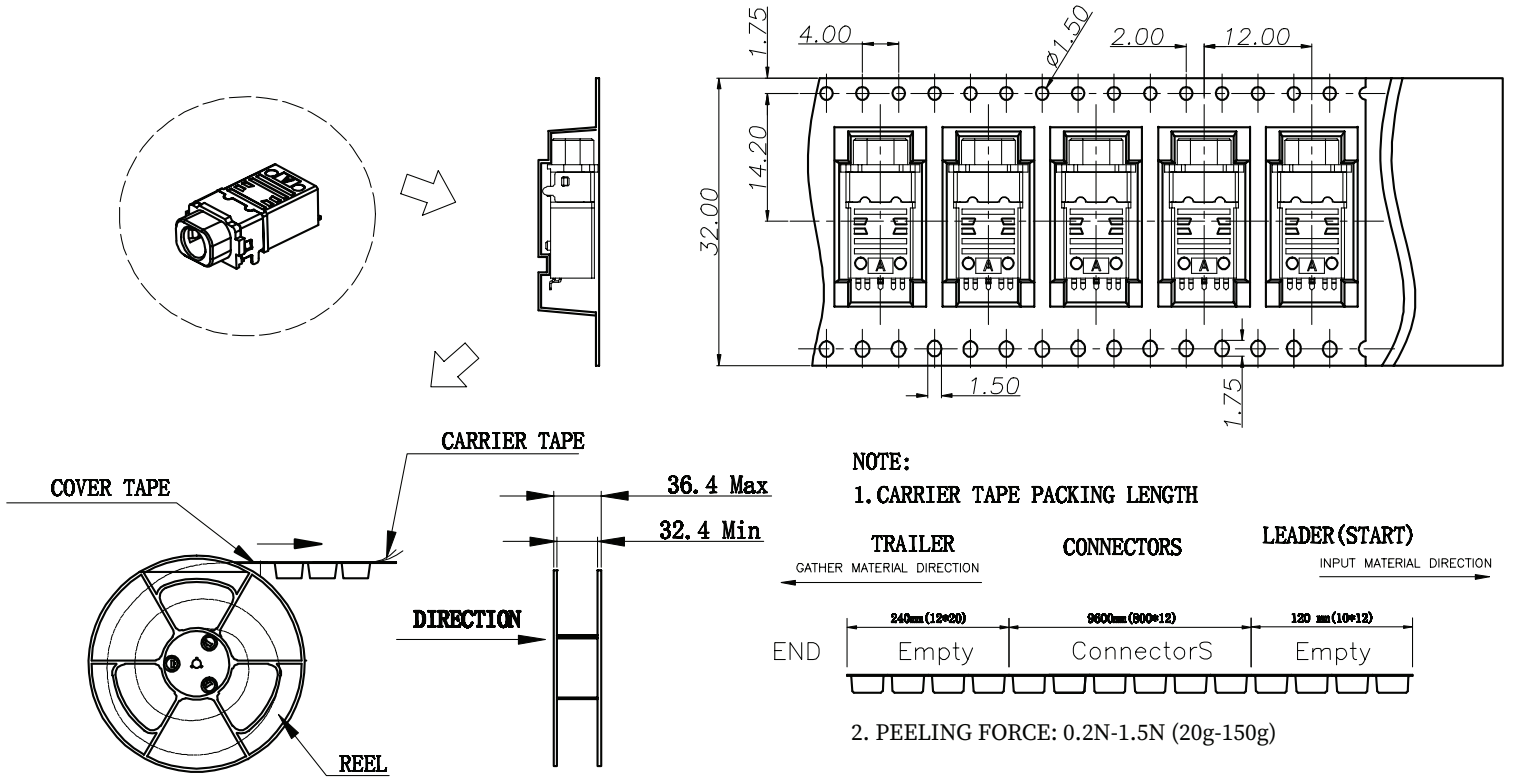

## REVISION HISTORY

rev.	description	date
1.0	initial release	09/30/2024

The revision history provided is for informational purposes only and is believed to be accurate.



Same Sky offers a one (1) year limited warranty. Complete warranty information is listed on our website.

Same Sky reserves the right to make changes to the product at any time without notice. Information provided by Same Sky is believed to be accurate and reliable. However, no responsibility is assumed by Same Sky for its use, nor for any infringements of patents or other rights of third parties which may result from its use.

Same Sky products are not authorized or warranted for use as critical components in equipment that requires an extremely high level of reliability. A critical component is any component of a life support device or system whose failure to perform can be reasonably expected to cause the failure of the life support device or system, or to affect its safety or effectiveness.

[sameskydevices.com](https://www.sameskydevices.com)