

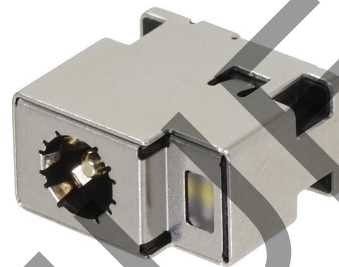

**MODEL:** PJ-099H-LED | **DESCRIPTION:** DC POWER JACK

**FEATURES**

- 1.65 mm center pin
- 5.0 A rating
- shielded
- vertical orientation
- LED

**SPECIFICATIONS**

parameter	conditions/description	min	typ	max	units
rated input voltage			24		Vdc
rated input current				5.0	A
contact resistance <sup>1</sup>	between terminal and mating plug between terminal in a closed circuit			50 30	mΩ mΩ
insulation resistance	at 500 Vdc between adjacent contacts	100			MΩ
voltage withstand	for 1 minute, 0.5 mA between adjacent contacts			500	Vac
insertion/withdrawal force		0.3		3	kg
operating temperature		-25		85	°C
life	at a rate of 24 cycles/minute		5,000		cycles
flammability rating	UL94V-0				
RoHS	yes				

Note: 1. When measured at a current of less than 100 mA/1 kHz  
2. All specifications measured at 10-35°C, humidity at 45-85%, under standard atmospheric pressure, unless otherwise noted.

**SOLDERABILITY**

parameter	conditions/description	min	typ	max	units
hand soldering	for max 5 seconds			300	°C

**LED ABSOLUTE MAXIMUM RATINGS (TA=25°C)**

parameter	conditions/description	min	typ	max	units
power dissipation (PD)	amber			52	mW
	white			74	mW
DC forward current (IF)	amber			20	mA
	white			20	mA
pulsed forward current (IFP) <sup>3</sup>	amber			90	mA
	white			90	mA
reverse voltage (VR)	amber			5	V
	white			5	V

Note: 3. Duty cycle 1/10, pulse width 0.1 ms.

**LED ELECTRO-OPTICAL CHARACTERISTICS (TA=25°C)**

parameter	conditions/description	min	typ	max	units	
forward voltage (Vf)	at If=20 mA	amber	1.7	2.0	2.6	V
	white	2.8	3.3	3.7	V	
luminous intensity (Iv)	at If=20 mA	amber	37.6	520	192.4	mcd
	white	100		1150	mcd	
wavelength (λd)	at If=20 mA	amber	600		612	nm
	white	X	0.28			
		Y	0.28			
reverse current (Ir)	at Vr=5 V			10	μA	
viewing angle (2θ1/2)	at If=20 mA		130		deg	

Note: 4. Luminous intensity ±10%; forward voltage ±0.1 V; wavelength ±0.5 nm, (X,Y) ±0.01 is standard testing.

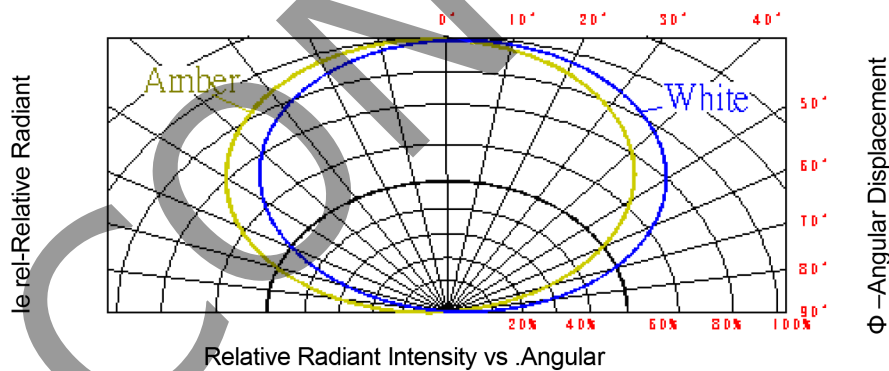

## LED CHARACTERISTIC CURVES

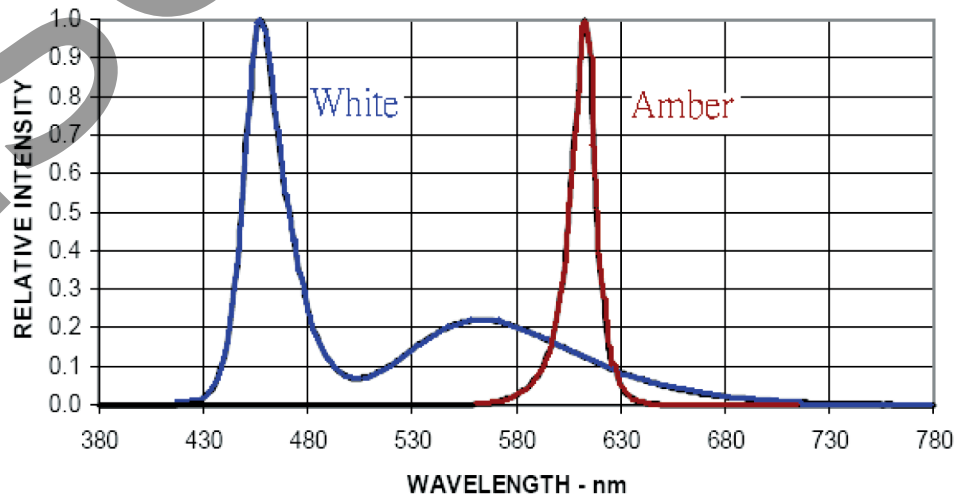
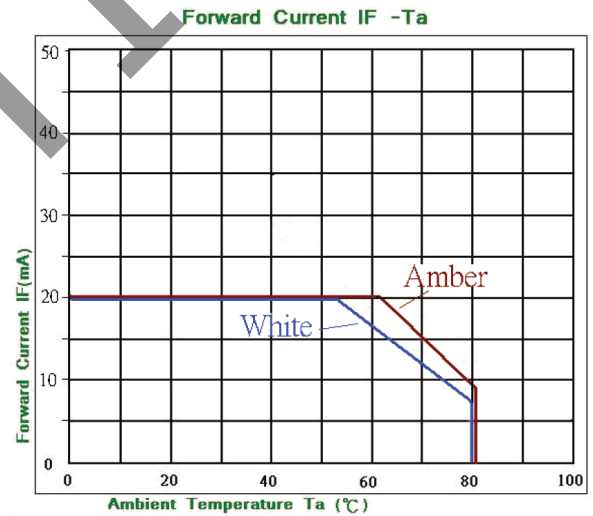
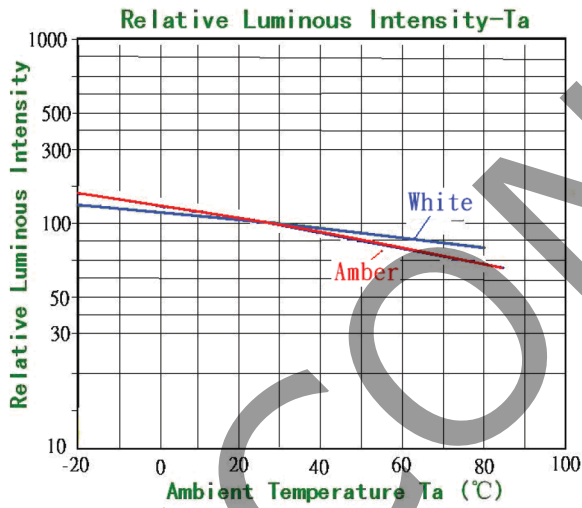
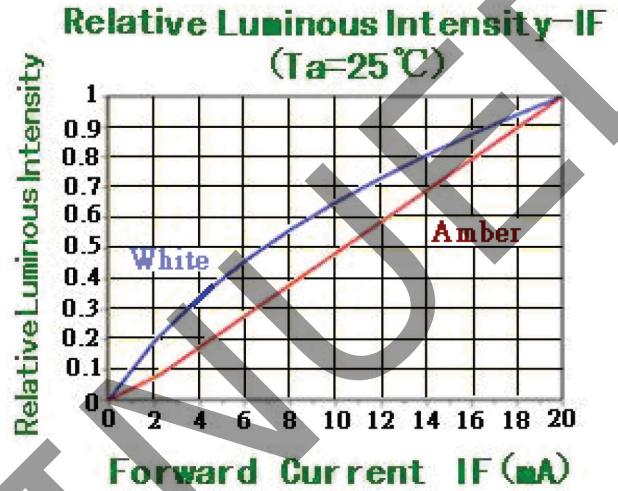
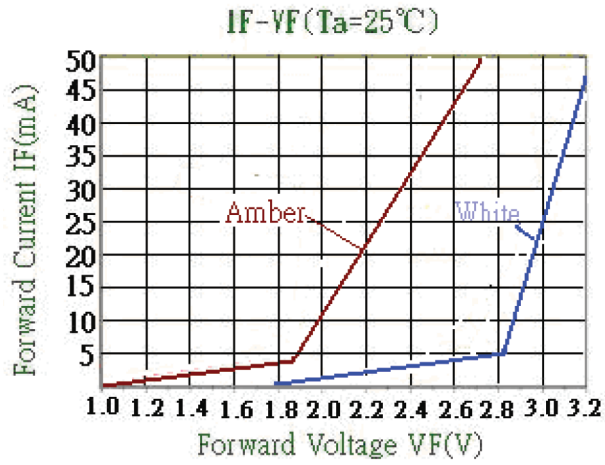

## MECHANICAL DRAWING

units: mm  
 tolerance:  
 X.X ±0.2 mm  
 X.XX ±0.10 mm  
 X.XXX ±0.050 mm

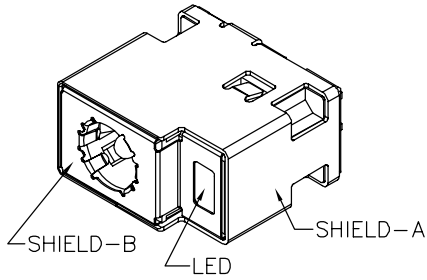

	MATERIAL	PLATING
center pin	copper	gold flash
terminal 1	copper	gold flash
terminal 2	copper alloy	gold flash
terminal 3	iron alloy	silver
terminal 4	iron alloy	silver
shield-A	brass	nickel
shield-B	stainless steel	
insulator	PA66	

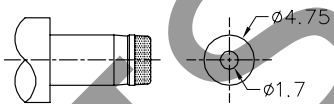
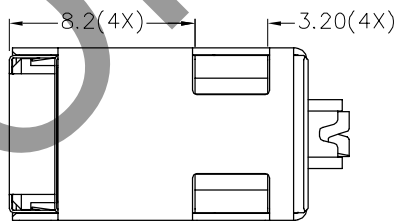
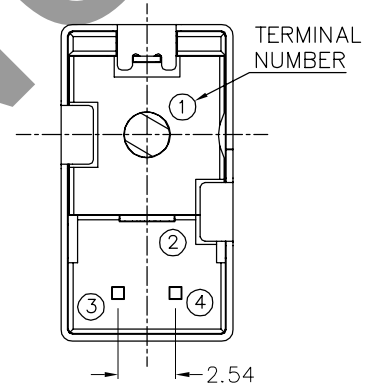
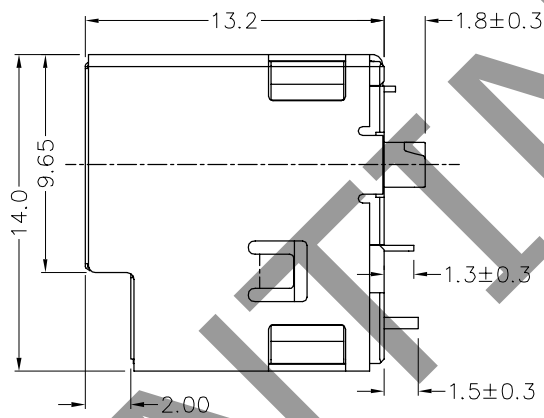
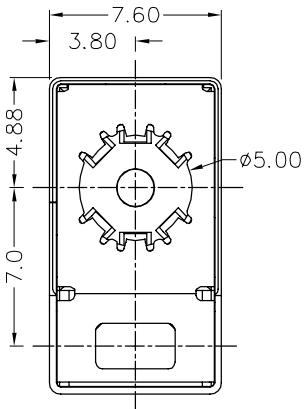

MATING PLUG  
 Jack Insertion Depth: 8.4 mm

Schematic	
Model	PJ-099H-LED
Center Pin	Ø1.65 mm

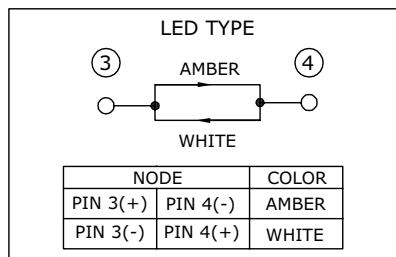

## REVISION HISTORY

rev.	description	date
1.0	initial release	12/17/2018
1.01	brand update	10/25/2019
1.02	logo, datasheet style update	08/05/2022

The revision history provided is for informational purposes only and is believed to be accurate.



CUI Devices offers a one (1) year limited warranty. Complete warranty information is listed on our website.

CUI Devices reserves the right to make changes to the product at any time without notice. Information provided by CUI Devices is believed to be accurate and reliable. However, no responsibility is assumed by CUI Devices for its use, nor for any infringements of patents or other rights of third parties which may result from its use.

CUI Devices products are not authorized or warranted for use as critical components in equipment that requires an extremely high level of reliability. A critical component is any component of a life support device or system whose failure to perform can be reasonably expected to cause the failure of the life support device or system, or to affect its safety or effectiveness.

[cuidevices.com](http://cuidevices.com)