

AMT-OTZ-1 USER GUIDE

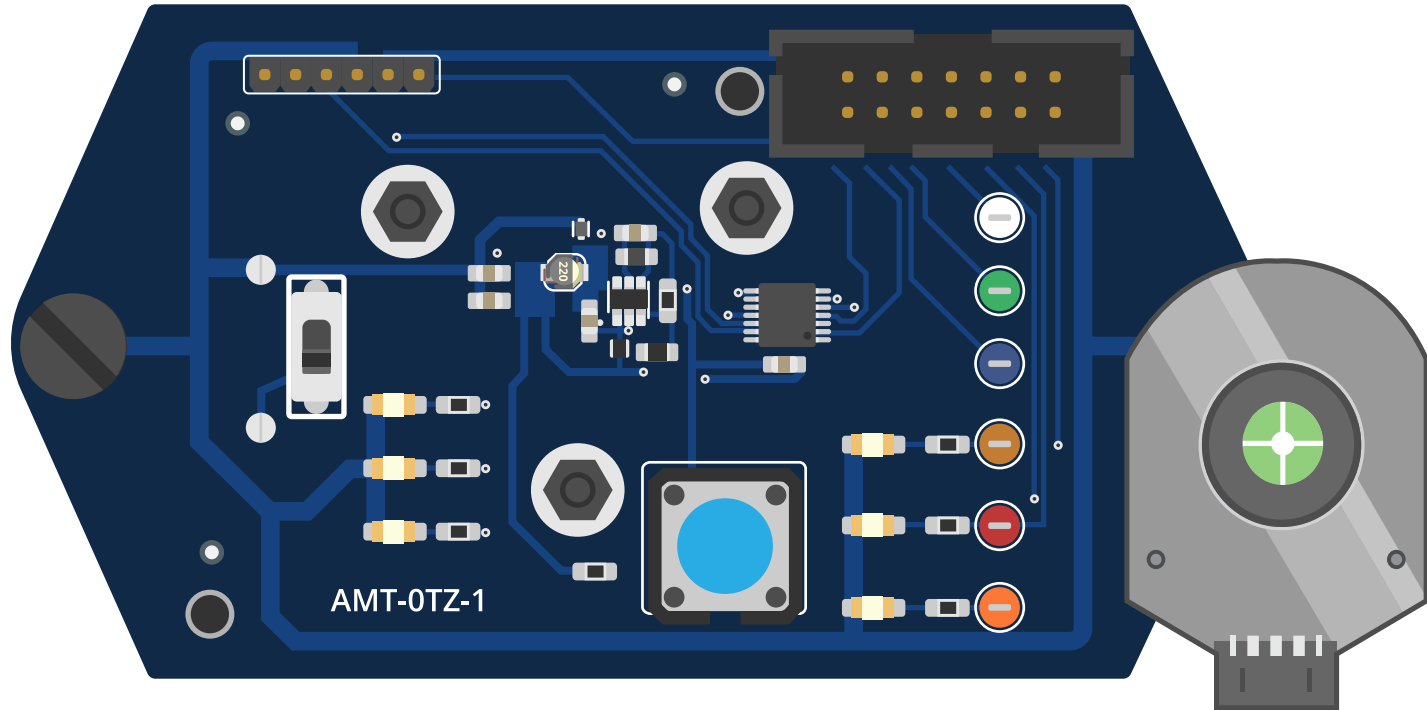

Table of Contents

Introduction & Features	1
What You'll Need	2
Components & Assembly	3
Zeroing Procedure	4
Using Test Points	10

Introduction & Features

The AMT-OTZ-1 One Touch Zero module is a simple and intuitive alignment tool for the AMT31 series commutation encoder. The module allows unprecedented time savings during the encoder alignment process. With the simple press of a button, the AMT31 series encoder can be instantly aligned to a brushless dc (BLDC) motor, eliminating the traditionally time consuming alignment process and removing the need for a motor back-driving fixture and oscilloscope. Because of the compact size of the AMT-OTZ-1 module and its common 9V size battery source, it is perfect for use anywhere, from an engineer's desk to the manufacturing floor.

Features:

- Easy "One Touch Zero"
- A/B/Z/U/V/W test points
- LEDs indicating status of each commutation signal
- Universal 9 V battery source
- ON/OFF switch for power saving
- Small handheld size

What You'll Need

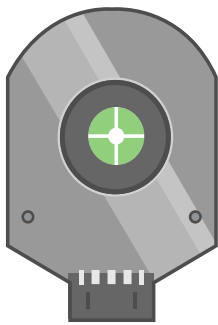

AMT31 Encoder

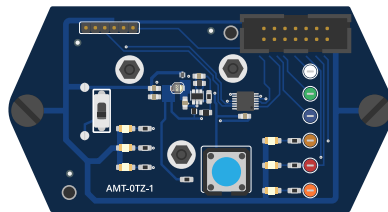

AMT One Touch Zero

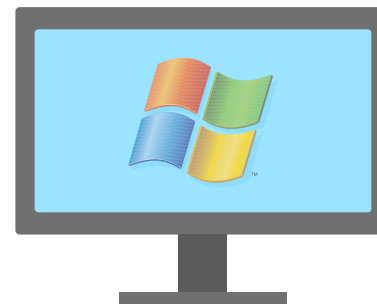

A Windows PC
(Vista or newer OS required)
[optional]

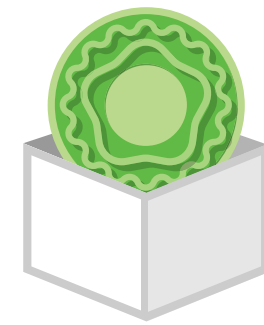

AMT Viewpoint™ GUI
[optional]



AMT313: AMT-14C-1-012-OTZ



AMT312: AMT-17C-1-012-OTZ



1 Universal 9 V Battery
[not included]

Components & Assembly

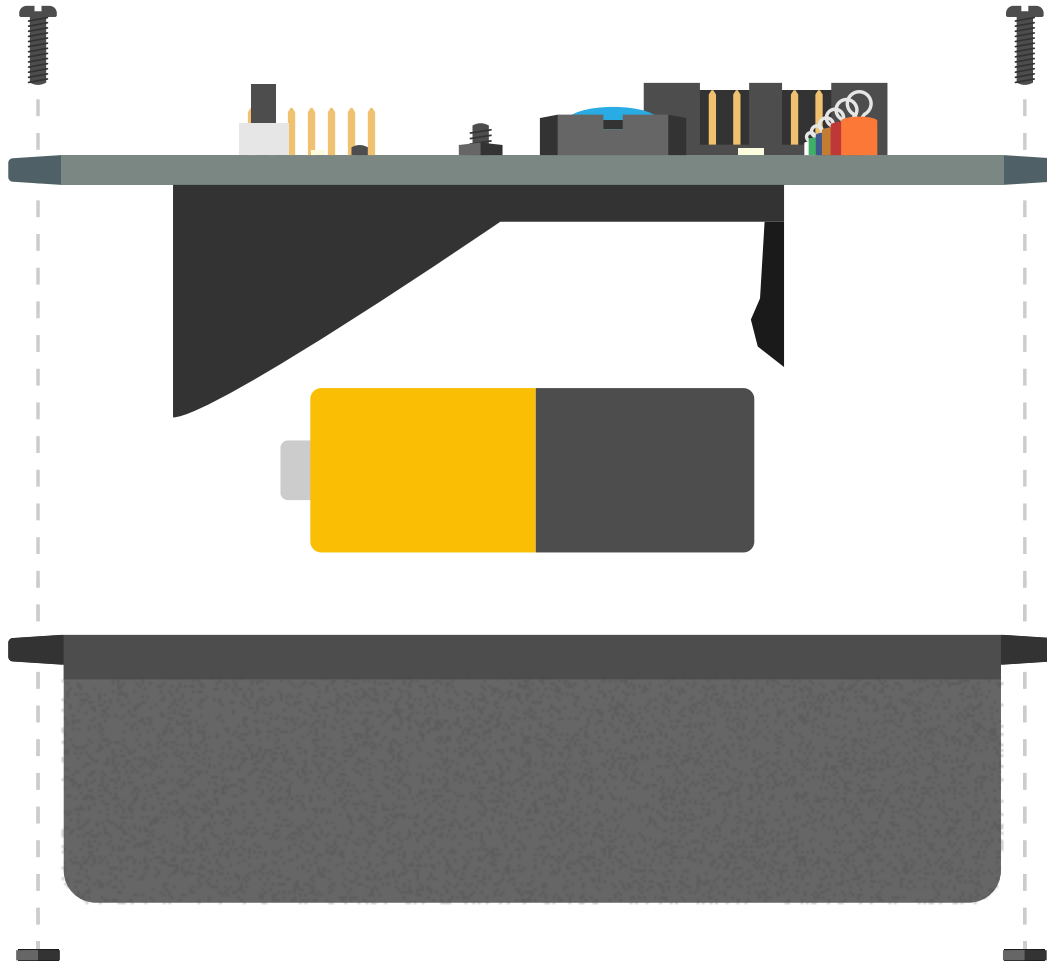

AMT-OTZ-1 Includes:

- AMT One Touch Zero Board
- AMT One Touch Zero Base
- 2 Screws and Nuts
- AMT Cable

Assembly:

- 1 Attach 9 V battery to the board
- 2 Place board on top of base
- 3 Fasten the board and base together with the two screws and nuts provided

Zeroing Procedure

- 1 **Optional:** Program AMT31 series commutation encoder with correct resolution, pole configuration, and direction settings using [AMT Viewpoint™](#).

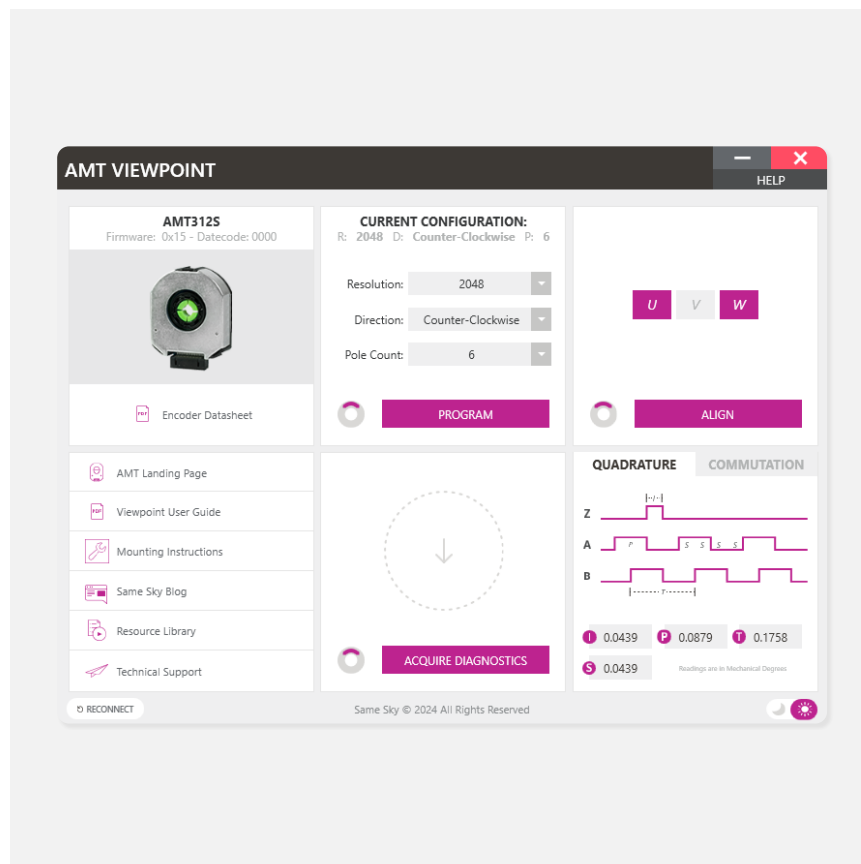

- 2 Mount the encoder to your motor using all tools provided with the AMT31-V kit. [Watch the assembly video](#) for step-by-step directions.



Zeroing Procedure

3 Turn on the AMT-OTZ-1 module.

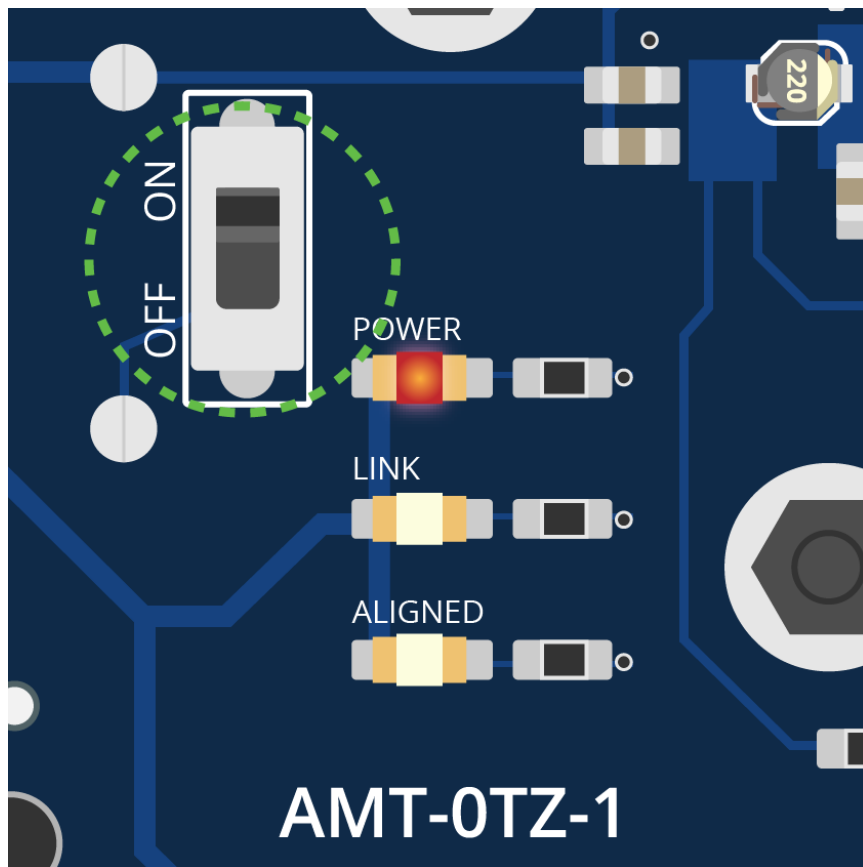

4 Connect AMT31 encoder.

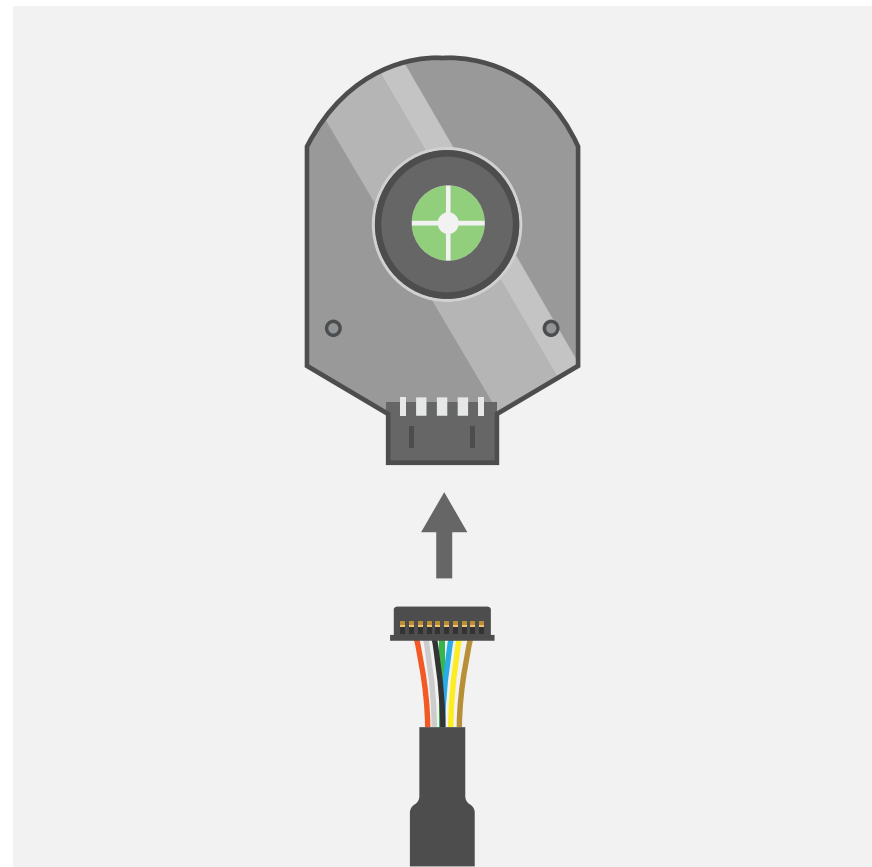

Zeroing Procedure

5 The LINK LED will be illuminated if properly connected.

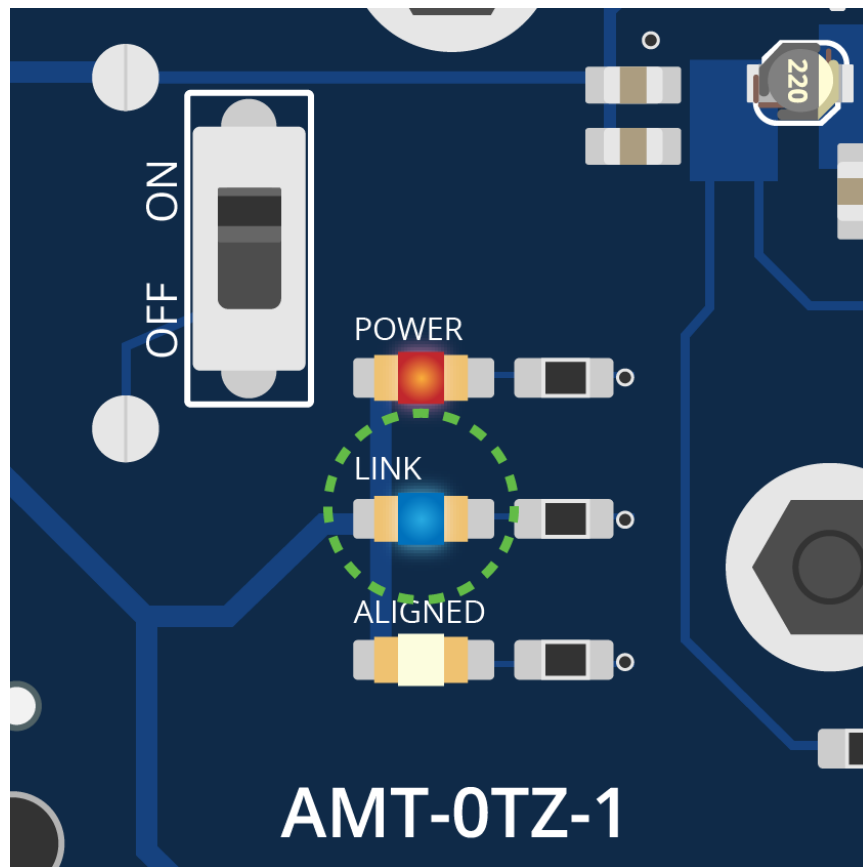

6 Energize or lock the motor windings into place where the encoder's U channel should have its rising edge. Once aligned this will be the zero position. Contact the motor manufacturer for additional information on commutation phase and timing diagrams.



Zeroing Procedure

7 Press the button to align the encoder to the motor.

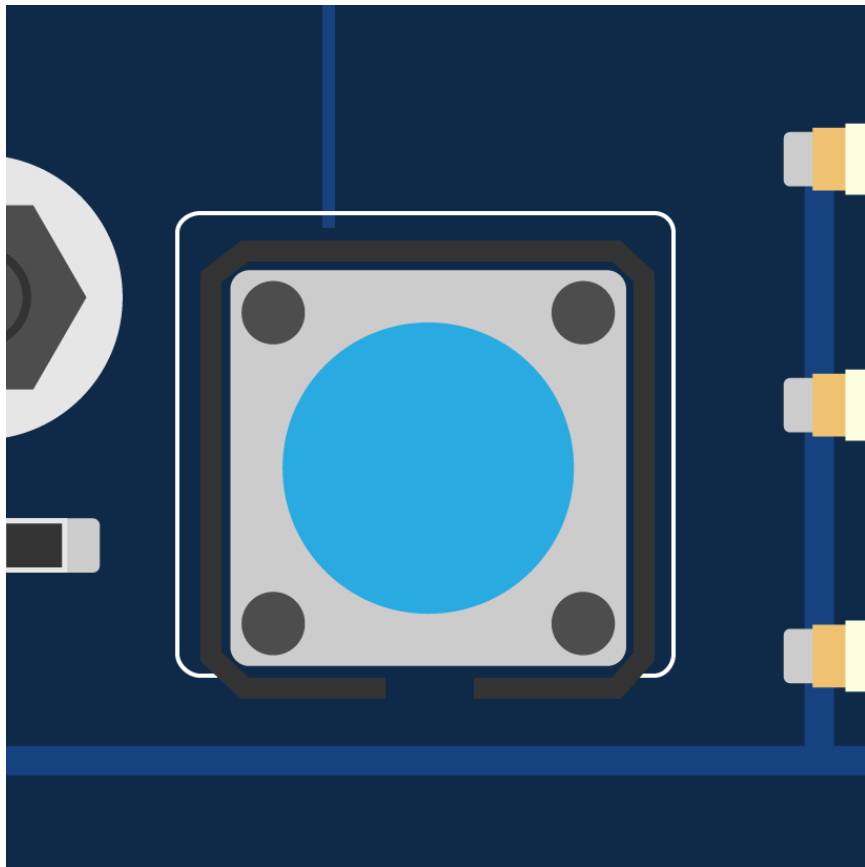

8 The ALIGNED LED will turn on briefly, and then flash three times to signify that alignment was a success.

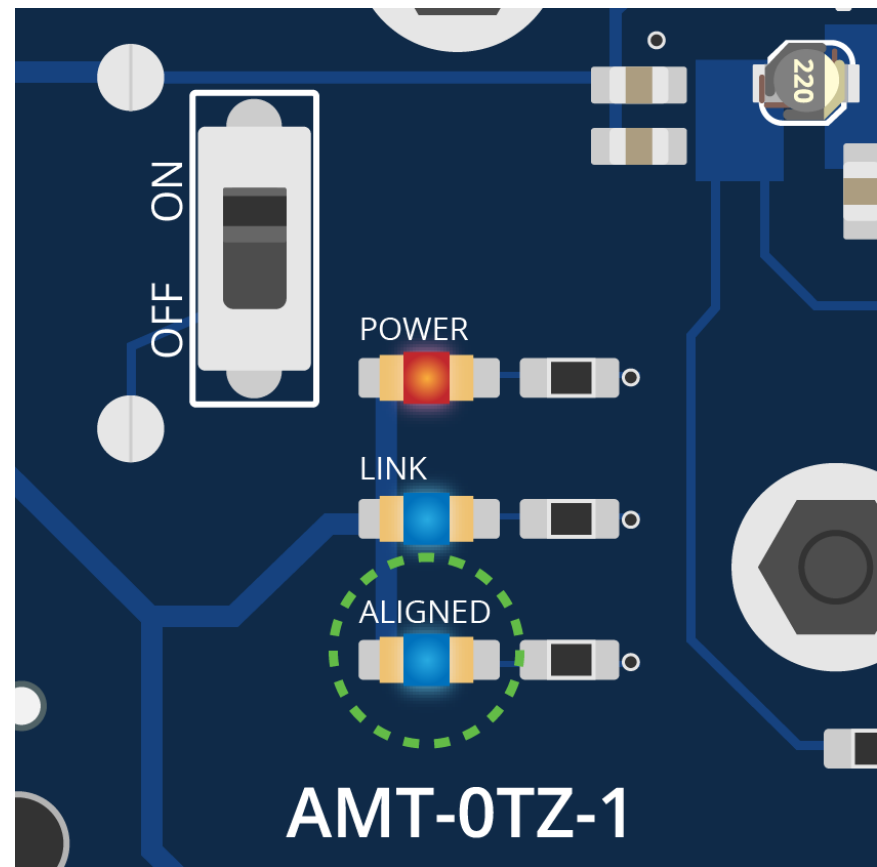

Zeroing Procedure

- 9 Green LEDs near the test points will indicate the commutation signals are now positioned at the rising edge of the 'U' channel.

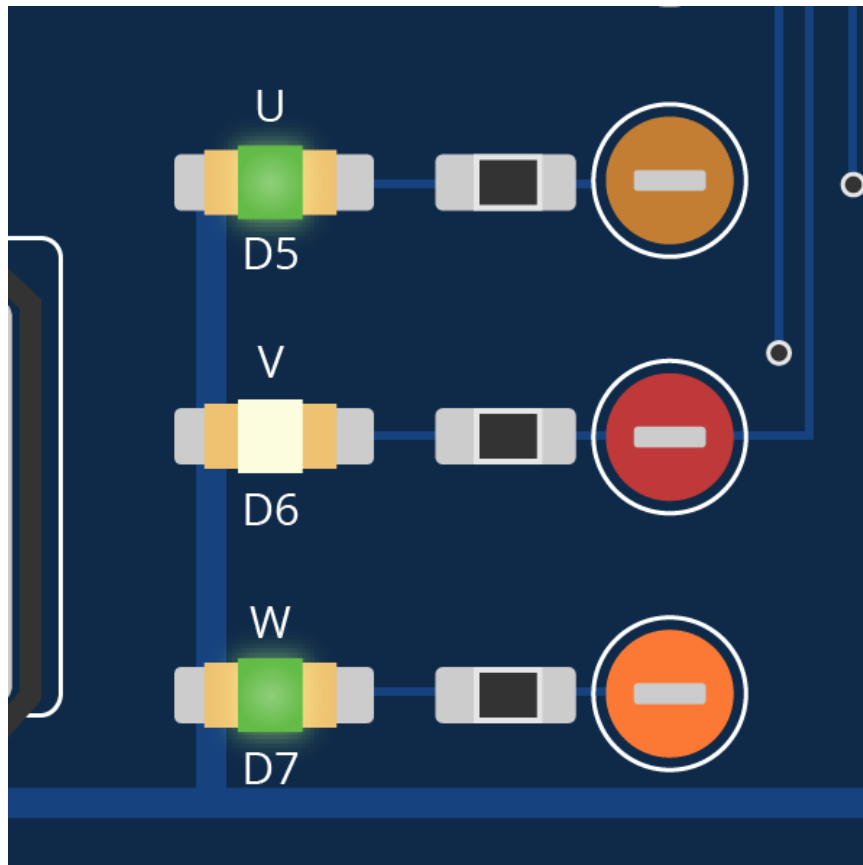

- 10 Disconnect the cable from the encoder and unlock the motor's windings.

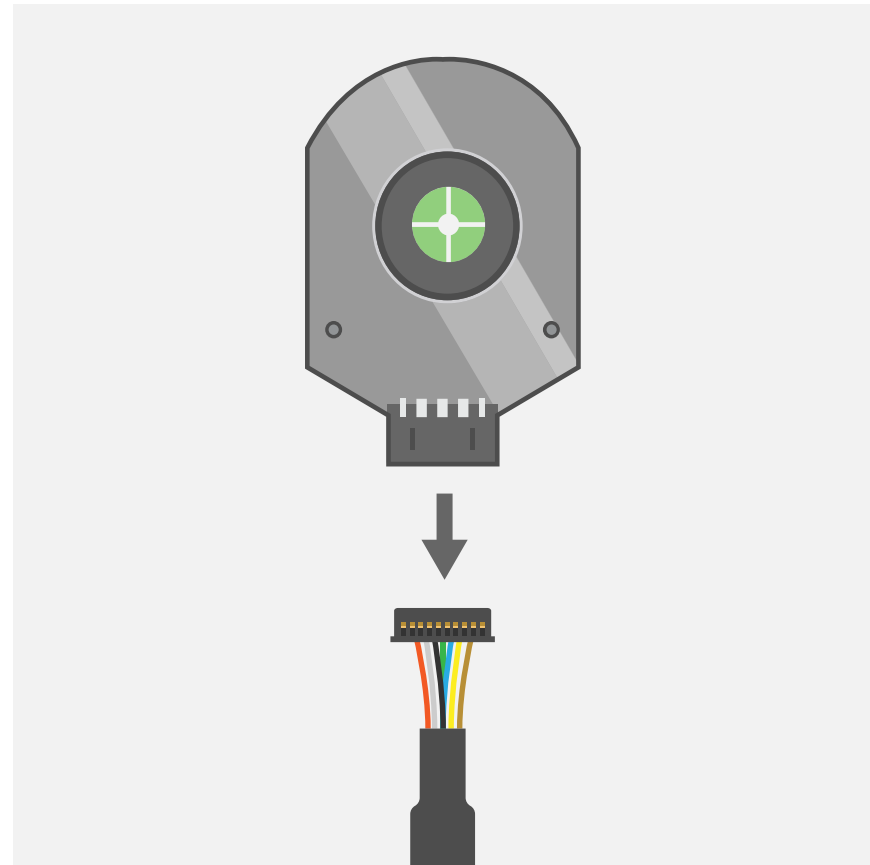

Zeroing Procedure

11 Repeat steps 1-9 for all other encoders requiring alignment.

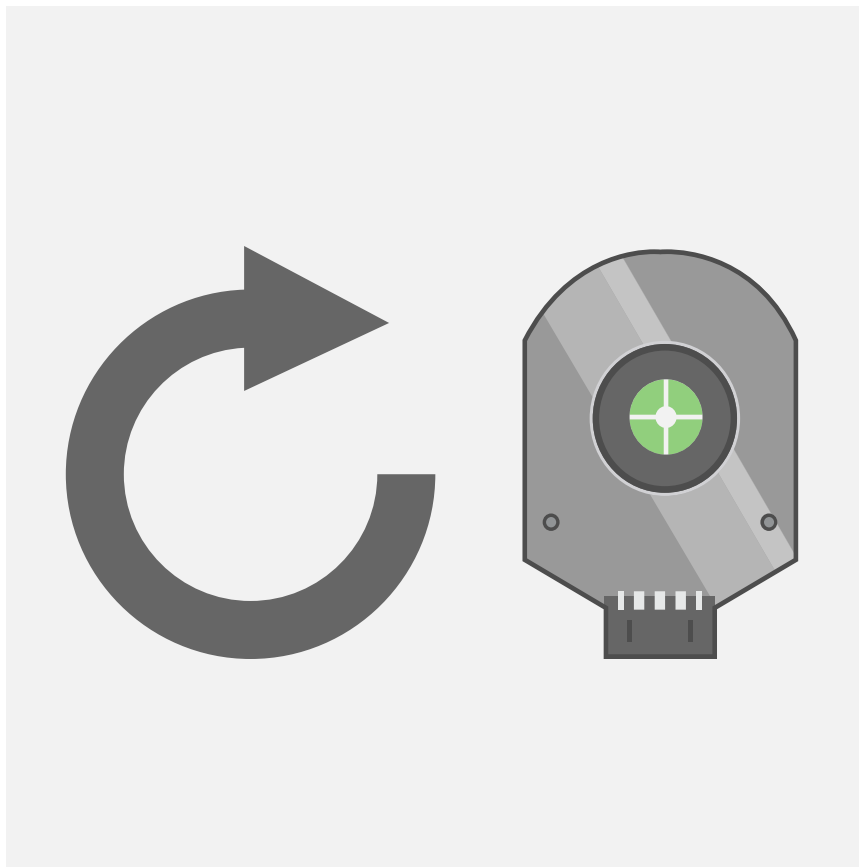

12 Be sure to turn the AMT-OTZ-1 module off after usage to preserve battery life.

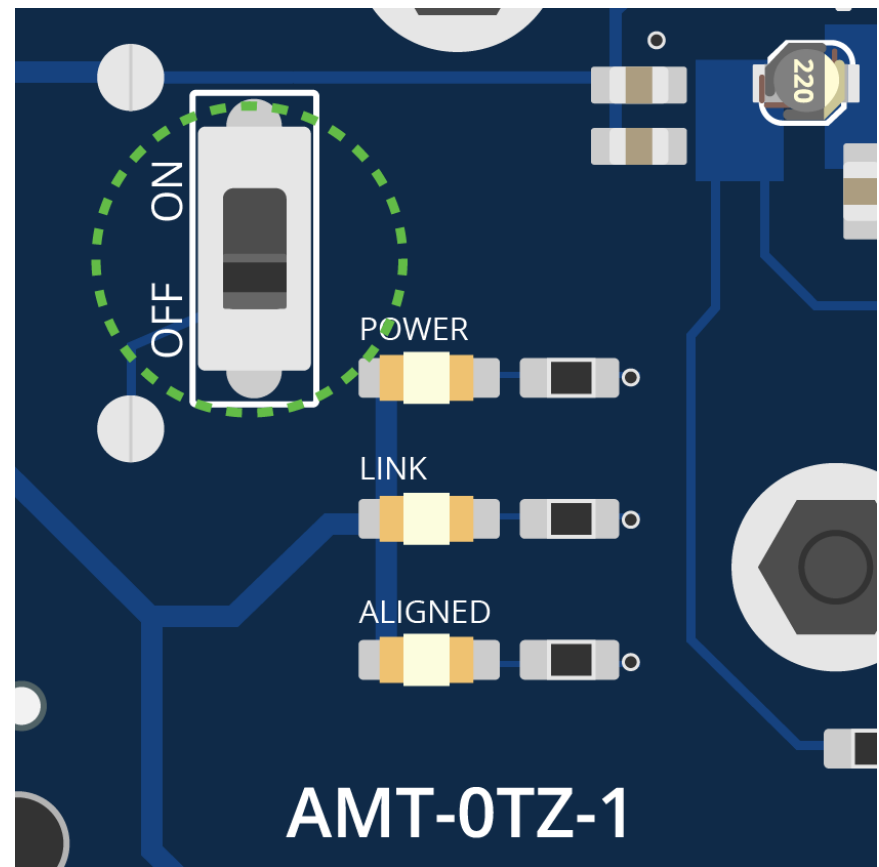

Using Test Points

- 1 The AMT-OTZ-1 module has test points for quadrature and commutation signals. These can be used for verifying encoder alignment or quick access to debugging the encoder.

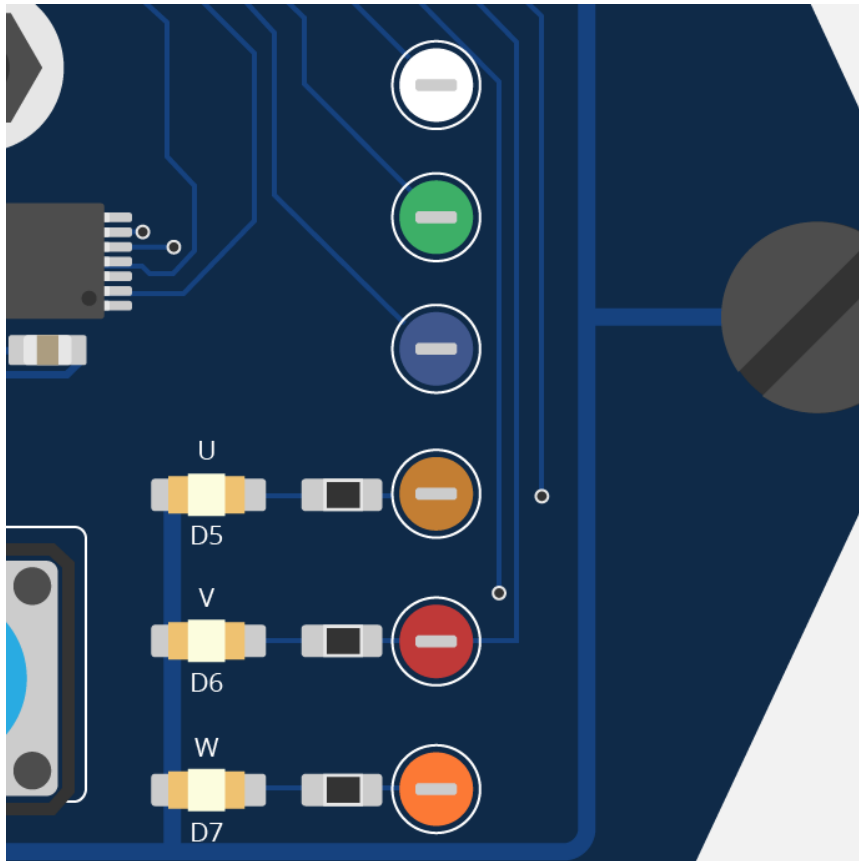

- 2 An oscilloscope probe or similar device may be used with the test points.

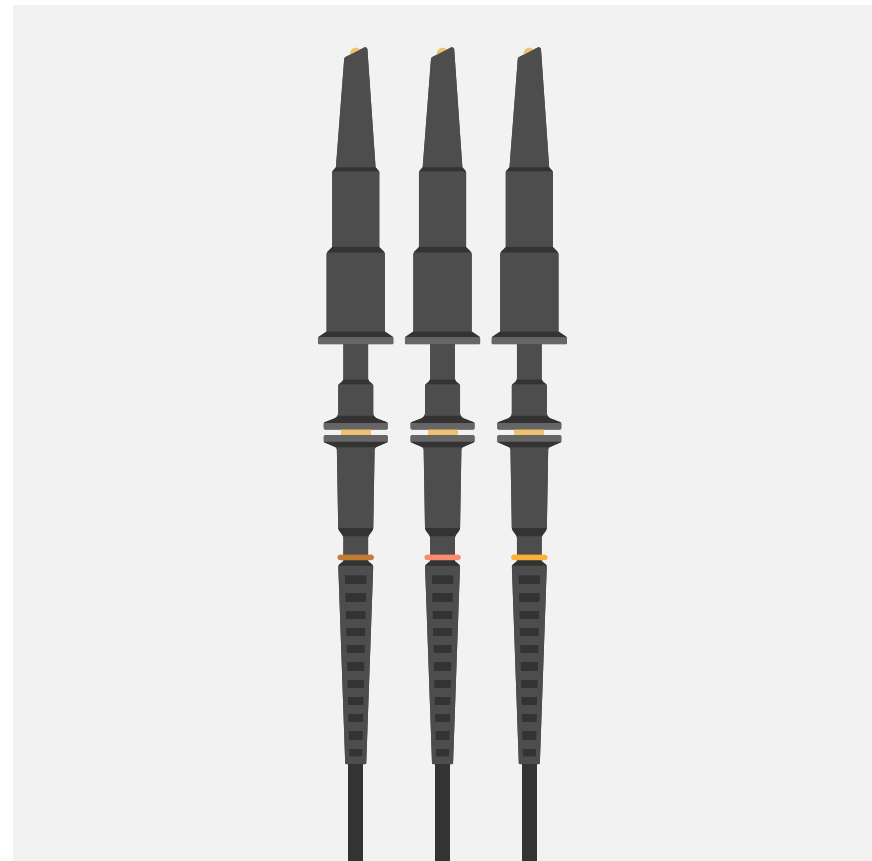

Using Test Points

3 Attach probes to the corresponding test points of interest.

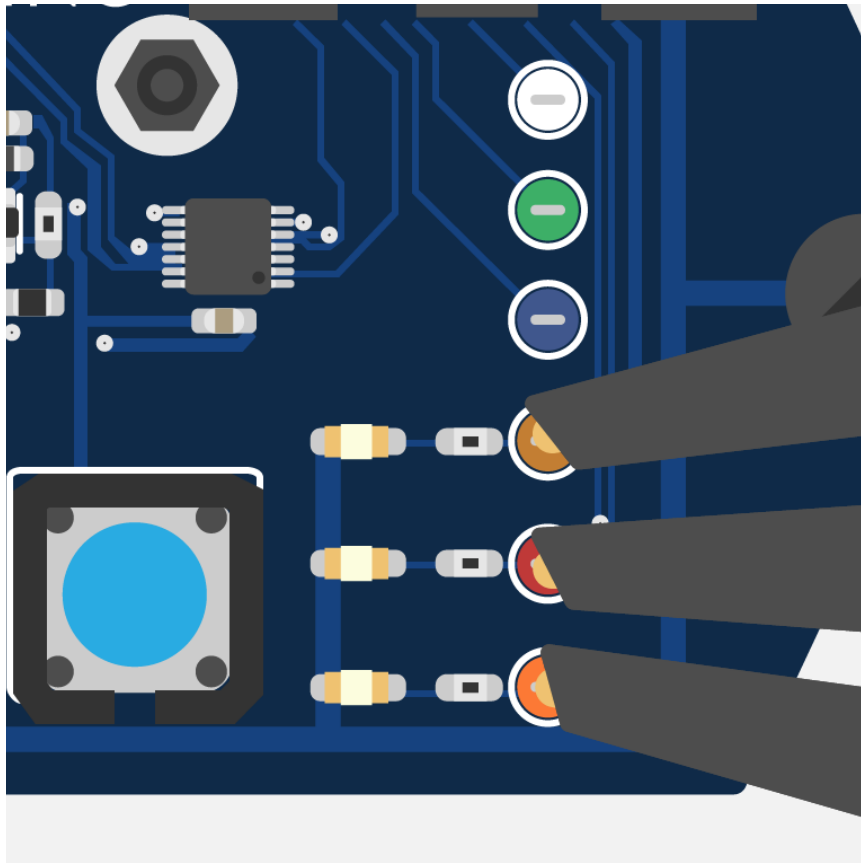

4 Use an oscilloscope or logic capture device to observe encoder signals.

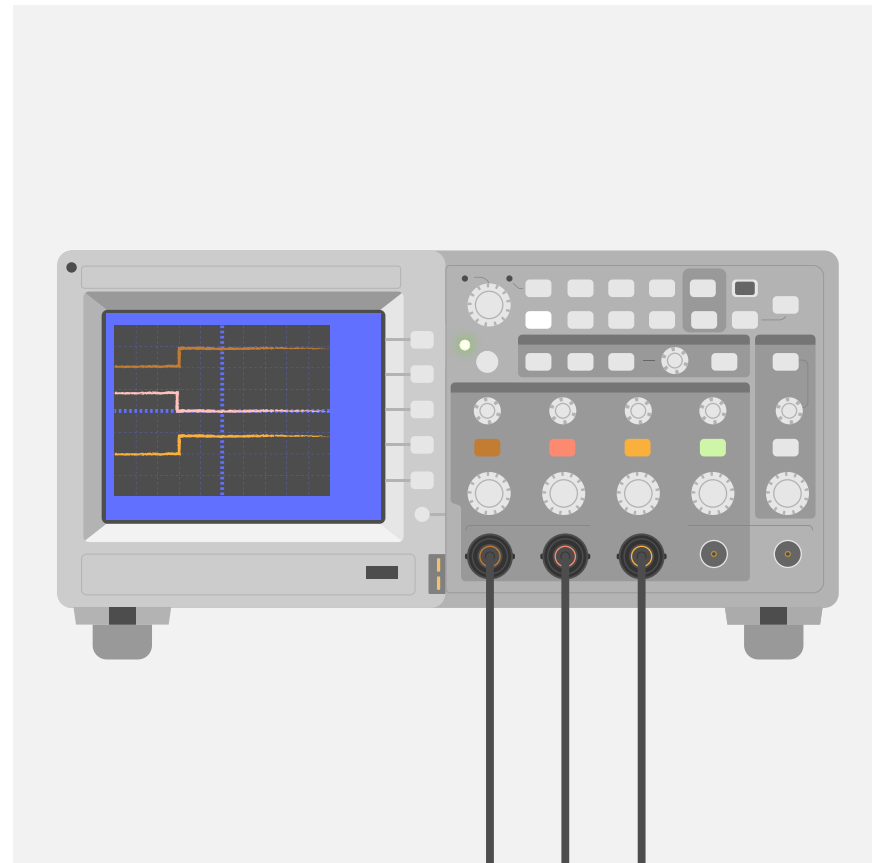

Thank you for using the AMT-OTZ-1.
If you have any questions, you can contact us at
www.sameskydevices.com/contact