



**MODEL:** CUSA-TR07-008-500-TH67 | **DESCRIPTION:** ULTRASONIC SENSOR

**FEATURES**

- aluminum can
- IP67 rated
- combination unit: receiver & transmitter
- high frequency



**SPECIFICATIONS**

parameter	conditions/description	min	typ	max	units
type	transmitter/receiver				
operating voltage	at 400 kHz			400	Vp-p
frequency		385	400	415	kHz
echo sensitivity	at 0.2 m	200			mV
directivity	at -6 dB	5	7	9	degree
capacitance	at 1 kHz	350	500	650	pF
detectable range		0.05		0.8	m
response time	at 200 Vp-p, 400 kHz			0.29	ms
dimensions	Ø11 x 11				mm
material	aluminum				
terminal	pins (brass with tin plating)				
weight			2.4		g
operating temperature		-40		80	°C
storage temperature		-40		85	°C
RoHS	yes				
IP level	IP67				

**SOLDERABILITY**

parameter	conditions/description	min	typ	max	units
wave soldering				260	°C

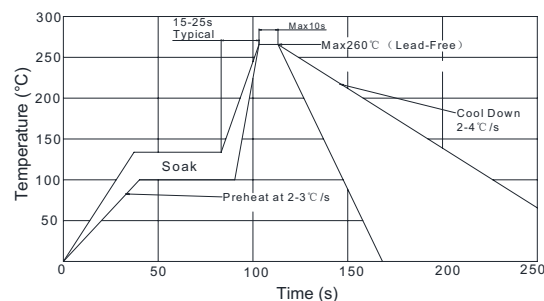

## MECHANICAL DRAWING

units: mm

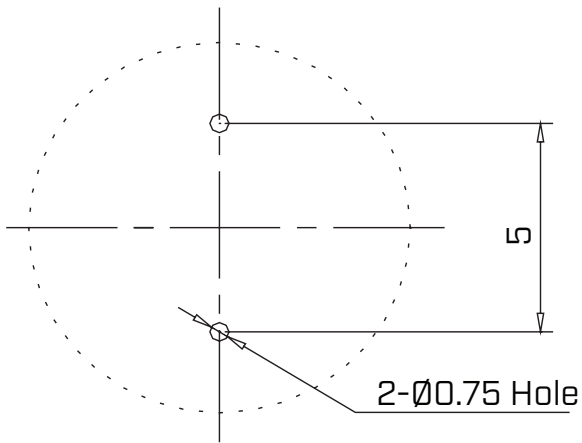
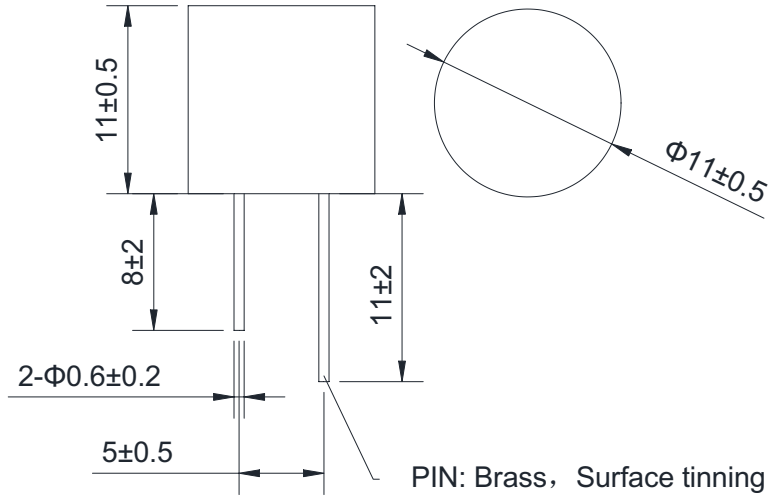

Recommended PCB Layout  
Top View

## BEAM PATTERNS

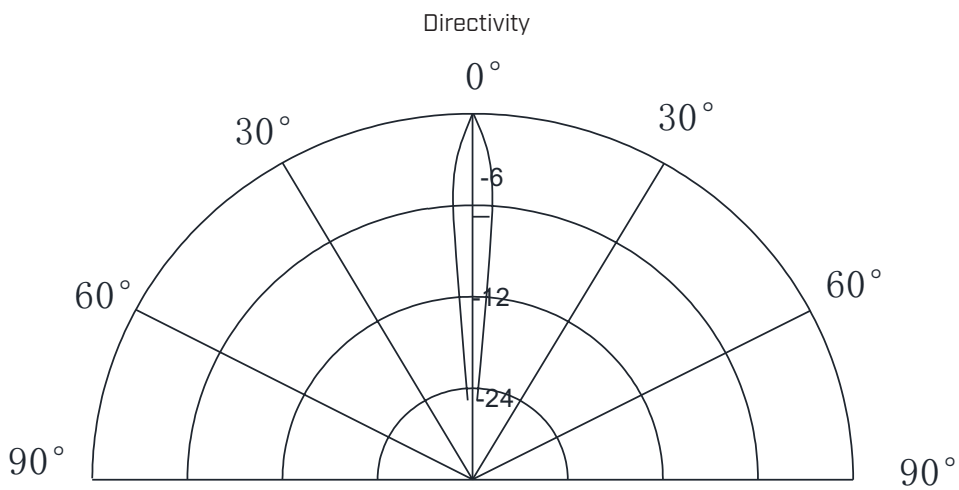

## PACKAGING

units: mm

Tray Size: 235 x 135 x 30 mm  
Tray QTY: 50 pcs per tray  
Carton Size: 280 x 285 x 240 mm  
Carton QTY: 1,000 pcs per carton

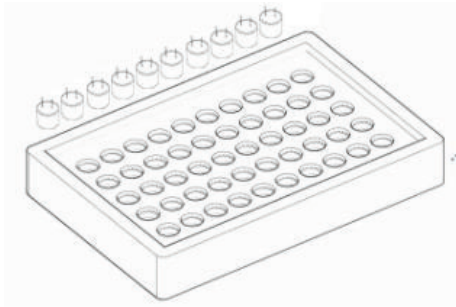

50PCS/BOX  
BOX SIZE:23.5\*13.5\*3CM

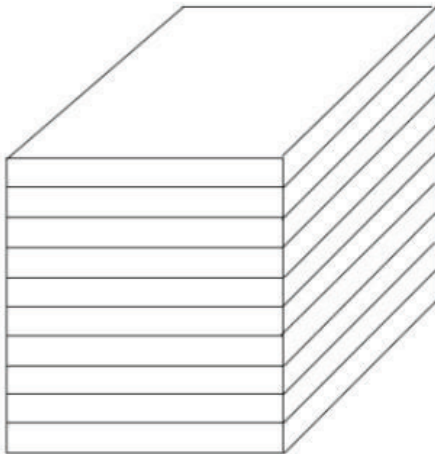

10BOXES/STACK, TOTAL 500PCS  
STACK SIZE:23.5\*13.5\*31CM

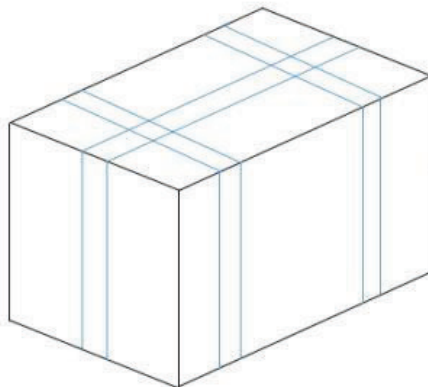

1000PCS/CARTON  
CARTON SIZE:28\*28.5\*24CM

## REVISION HISTORY

rev.	description	date
1.0	initial release	05/24/2022
1.01	logo, datasheet style update	08/05/2022
1.02	CUI Devices rebranded to Same Sky	09/12/2024

The revision history provided is for informational purposes only and is believed to be accurate.



Same Sky offers a one (1) year limited warranty. Complete warranty information is listed on our website.

Same Sky reserves the right to make changes to the product at any time without notice. Information provided by Same Sky is believed to be accurate and reliable. However, no responsibility is assumed by Same Sky for its use, nor for any infringements of patents or other rights of third parties which may result from its use.

Same Sky products are not authorized or warranted for use as critical components in equipment that requires an extremely high level of reliability. A critical component is any component of a life support device or system whose failure to perform can be reasonably expected to cause the failure of the life support device or system, or to affect its safety or effectiveness.

[sameskydevices.com](https://www.sameskydevices.com)