

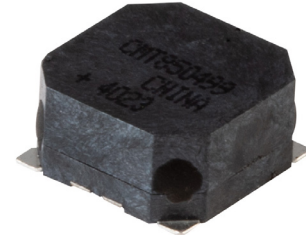

MODEL: CMT-8504-99-SMT-TR | **DESCRIPTION:** MAGNETIC BUZZER TRANSDUCER**FEATURES**

- magnetic
- 99 dB @ 0.1 m
- tape and reel

**SPECIFICATIONS**

| parameter | conditions/description | min | typ | max | units |
|-----------------------|---|-----|-------|-----|--------------------|
| rated voltage | V_{o-p}  | | 3.6 | | V_{o-p} |
| operating voltage | | 2.5 | | 4.5 | V_{o-p} |
| current consumption | at rated voltage, 2,730 Hz, ½ duty square wave | | | 100 | mA |
| rated frequency | | | 2,730 | | Hz |
| sound pressure level | at 10 cm, rated voltage, 2,730 Hz, ½ duty square wave | 94 | 99 | | dBA |
| coil resistance | | 13 | 16 | 19 | Ω |
| dimensions | 8.5 x 8.5 x 4.0 | | | | mm |
| weight | | | 0.6 | | g |
| material | LCP (black) | | | | |
| terminal | surface mount (tin plating) | | | | |
| operating temperature | | -40 | | 105 | $^{\circ}\text{C}$ |
| storage temperature | | -40 | | 120 | $^{\circ}\text{C}$ |
| washable | no | | | | |
| RoHS | yes | | | | |

Notes: 1. All specifications measured at 5-35 $^{\circ}\text{C}$, humidity at 45-85%, under 86-106 kPa pressure, unless otherwise noted.

MECHANICAL DRAWING

units: mm
tolerance: ±0.5 mm

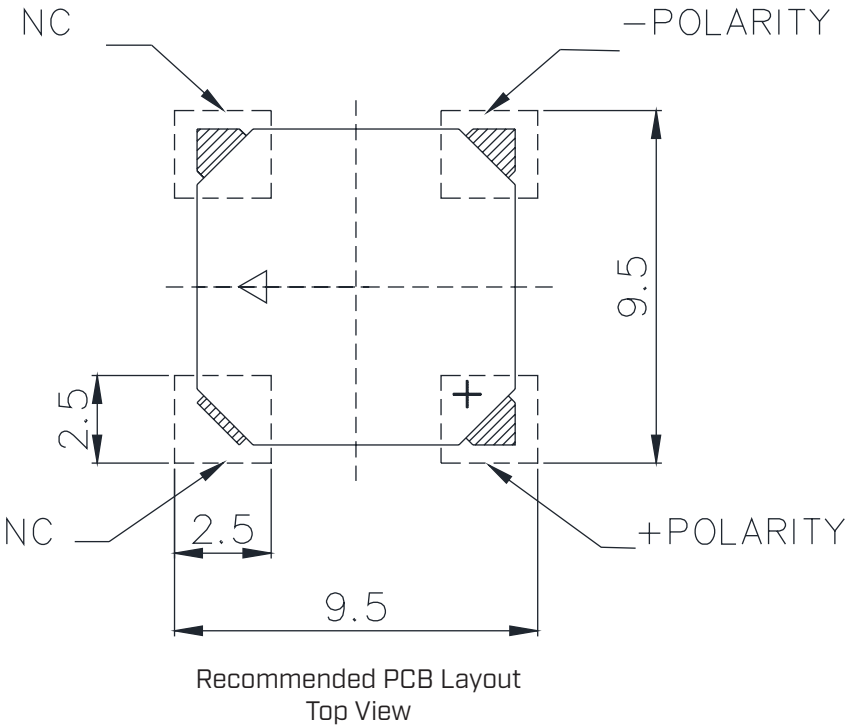
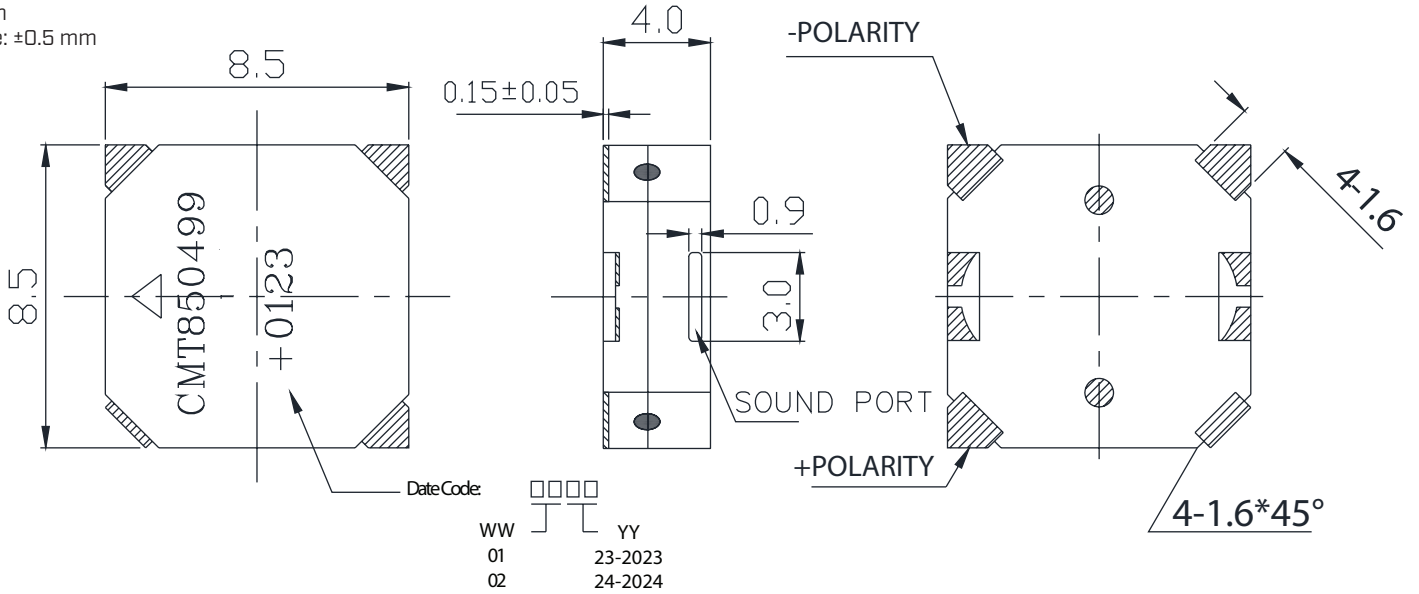

FREQUENCY RESPONSE CURVE

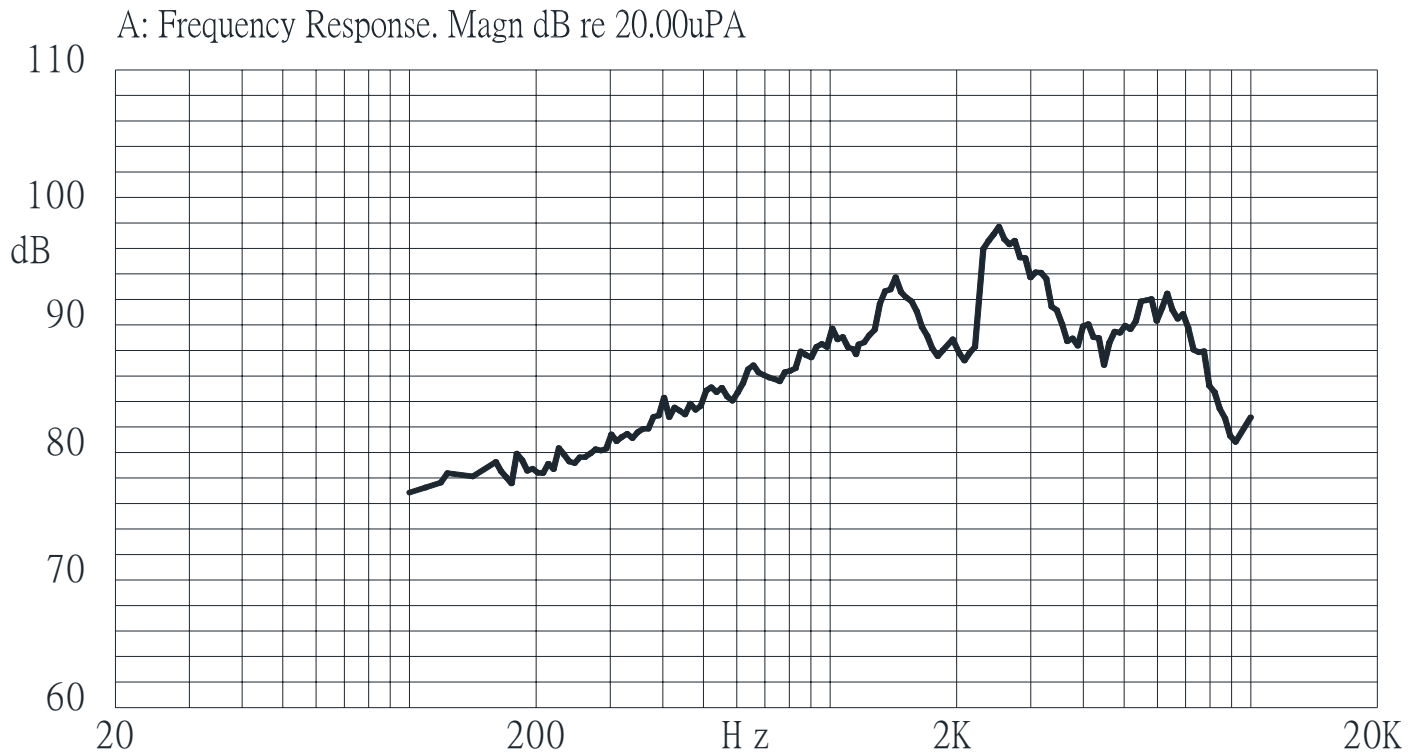

APPLICATION CIRCUIT



SOLDERABILITY

| parameter | conditions/description | min | typ | max | units |
|--------------------------------|-----------------------------|-----|-----|-----|-------|
| reflow soldering ⁴ | as per IPC/JEDEC J-STD-020C | | 240 | 245 | °C |
| drying conditions ⁵ | bake at 40°C for 24 hours | | | | |

- Note:
- Not suitable for wash process.
 - It is recommended to reflow solder only once.
 - It is recommended to reflow solder within 48 hours from opening vacuum packaging at a temperature <30°C & relative humidity <60%.
 - When out of packaging for more than 48 hours.

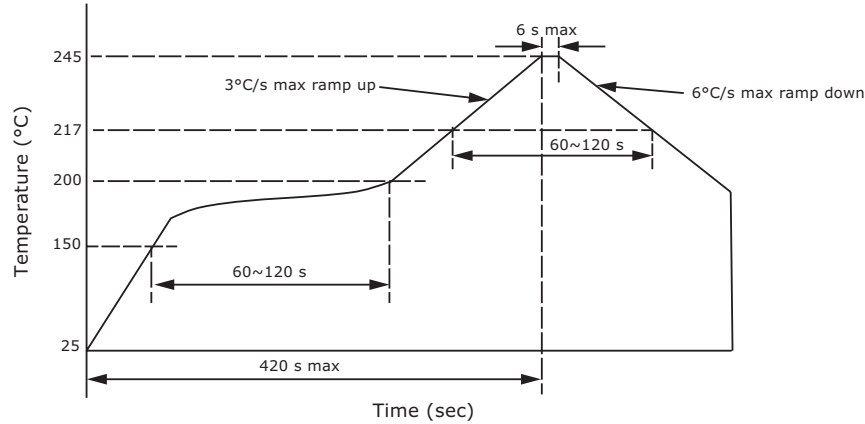

PACKAGING

| parameter | conditions/description | min | typ | max | units |
|---------------------------|-----------------------------|-----|-----|-----|-------|
| reel storage ⁶ | at relative humidity 15~85% | -10 | | 40 | °C |
| MSL | Class 4 | | | | |
| reel QTY | 1,000 | | | | |
| carton QTY | 5,000 | | | | |

- Note:
- Recommended floor life (out of sealed bag) at <30°C, 60%RH is 72 hours.

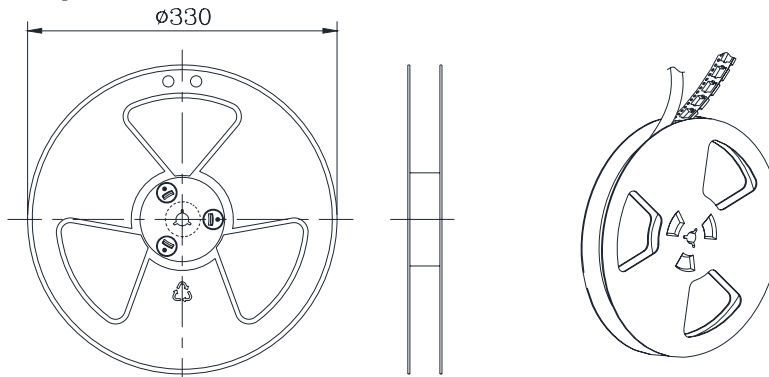

1 Reel : 1000PCS

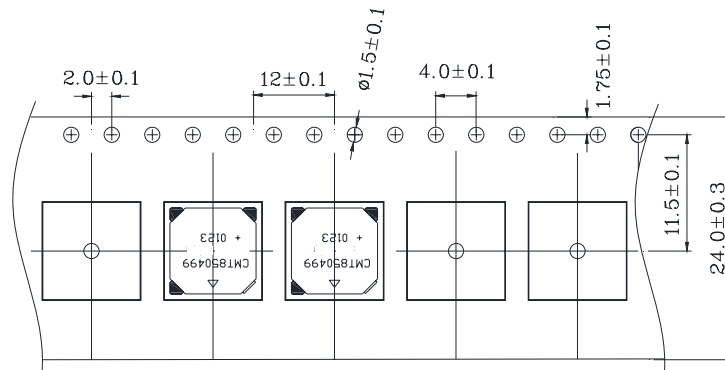

REVISION HISTORY

| rev. | description | date |
|------|-----------------------------------|------------|
| 1.0 | initial release | 12/19/2023 |
| 1.01 | CUI Devices rebranded to Same Sky | 09/11/2024 |

The revision history provided is for informational purposes only and is believed to be accurate.



Same Sky offers a one (1) year limited warranty. Complete warranty information is listed on our website.

Same Sky reserves the right to make changes to the product at any time without notice. Information provided by Same Sky is believed to be accurate and reliable. However, no responsibility is assumed by Same Sky for its use, nor for any infringements of patents or other rights of third parties which may result from its use.

Same Sky products are not authorized or warranted for use as critical components in equipment that requires an extremely high level of reliability. A critical component is any component of a life support device or system whose failure to perform can be reasonably expected to cause the failure of the life support device or system, or to affect its safety or effectiveness.

[sameskydevices.com](https://www.sameskydevices.com)