

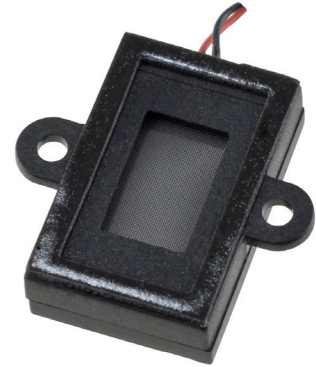

**SERIES:** CES-20134-088PM | **DESCRIPTION:** SPEAKER

**FEATURES**

- 0.8 W power rating
- dust proof mesh
- 60 mm lead wire
- 2 panel mount flanges
- wire leads with connector options



**SPECIFICATIONS**

parameter	conditions/description	min	typ	max	units
input power	max power: 1 second on, 59 seconds off, 60 cycles		0.8	1.0	W
impedance	at 2.0 kHz, 2.53 Vrms	6.4	8	9.6	$\Omega$
resonant frequency (Fo)	at 2.53 Vrms, 10 cm	1,040	1,300	1,560	Hz
frequency response	as per IEC 268-5	500		20,000	Hz
sound pressure level	at 0.8 W, 10 cm, avg at 1.1, 1.3, 1.5 & 2 kHz	88	91	94	dB
distortion	at 2.0 kHz, rated power, 10 cm			10	%
buzz, rattle, etc.	must be normal at sine wave, frequency range			2.53	V
polarity	cone moves forward w/ positive dc current to "+" terminal				
dimensions	20 x 13 x 4.87				mm
magnet	Nd-Fe-B				
enclosure material	ABS+PC				
cone material	PEEK				
terminal	wire leads				
weight		1.5	2	2.5	g
operating temperature		-20		70	$^{\circ}\text{C}$
storage temperature		-40		85	$^{\circ}\text{C}$
RoHS	yes				

Notes: 1. All specifications measured at 15-35°C, humidity at 25-75%, under 86-106 kPa pressure, unless otherwise noted.

**PART NUMBER KEY**

**CES-20134-088PM X**

Base Number

Termination Options:

"blank" = wire leads, no connector

A = wire leads with Molex housing 51021-0200

B = wire leads with JST housing SHR-02V-S-B

## MECHANICAL DRAWINGS

units: mm  
tolerance:  $\pm 0.2$  mm

### WIRE LEADS, NO CONNECTOR

wire: UL 1571 32 AWG  
internal speaker: CMS-151103-088SP

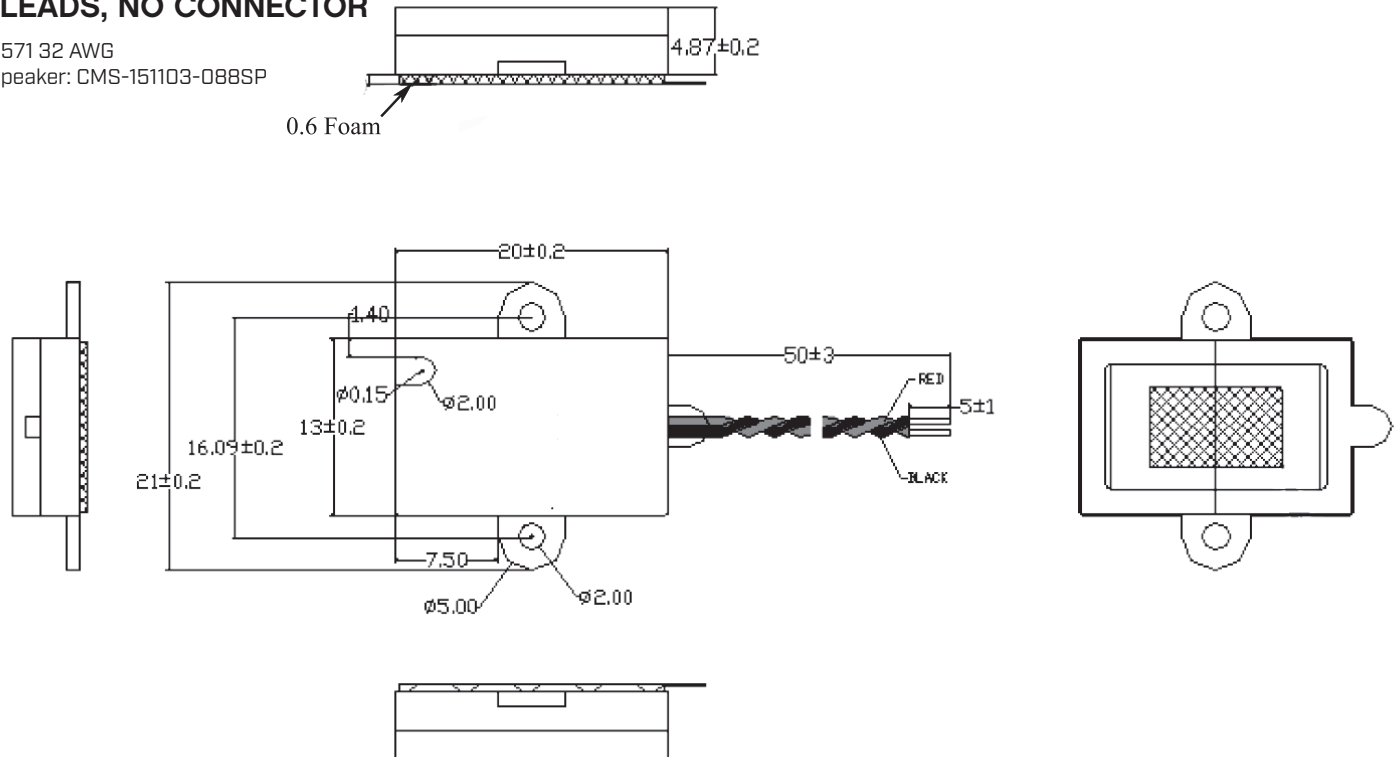

### WIRE LEADS WITH MOLEX CONNECTOR

wire: UL 1571 30 AWG  
connector: Molex 51021-0200  
mating connector: Molex 53261-0271  
internal speaker: CMS-151103-088SP

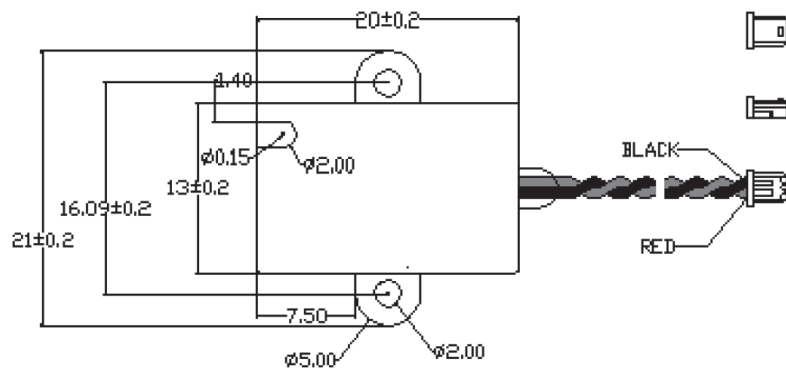

### WIRE LEADS WITH JST CONNECTOR

wire: UL 1571 30 AWG  
connector: JST SHR-02V-S-B  
mating connector: JST BMD2B-SRSS-TB  
internal speaker: CMS-151103-088SP

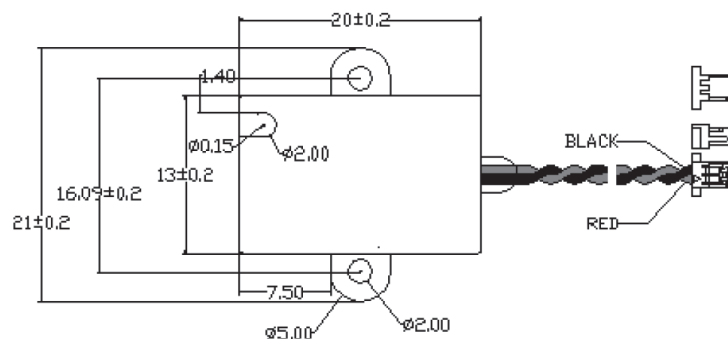

## RESPONSE CURVES

### Frequency Response Curve

Test Conditions: 2.53 Vrms / 10 cm

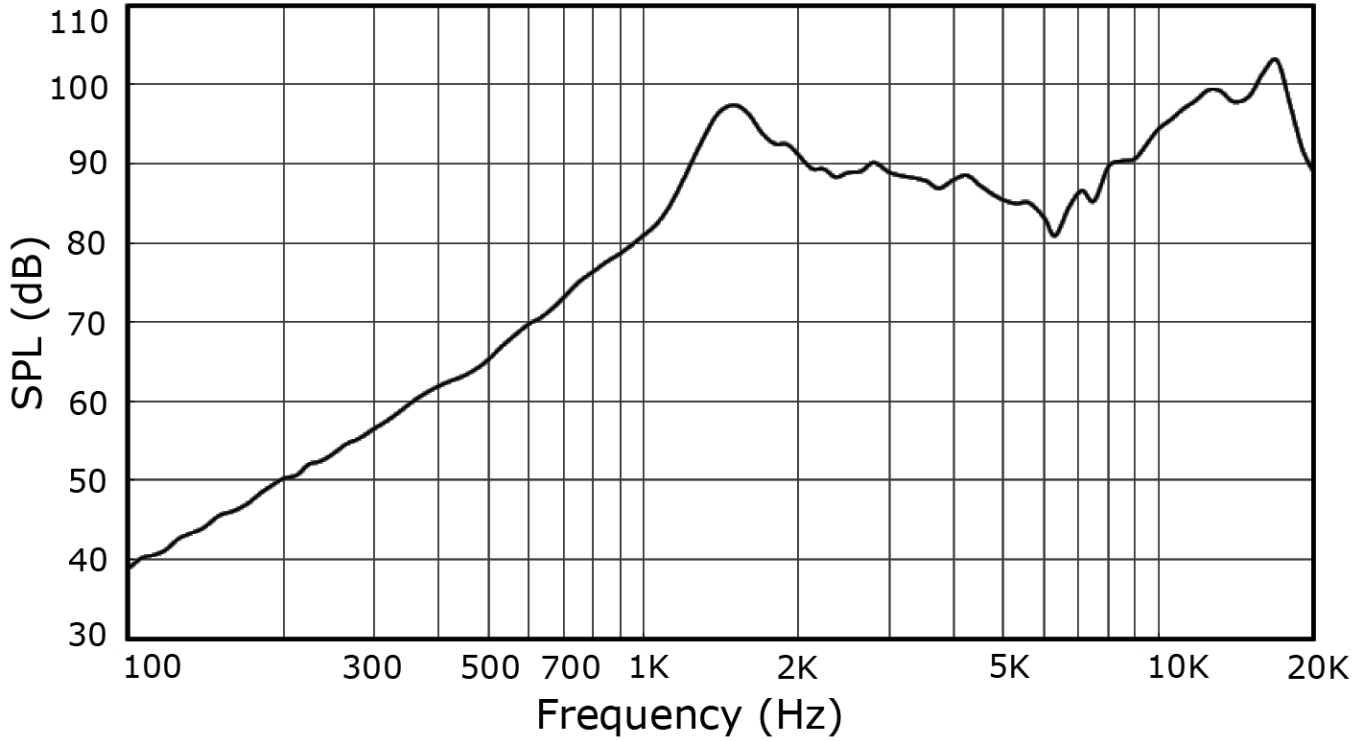

### Total Harmonic Distortion Curve

Test Conditions: 2.53 Vrms / 10 cm

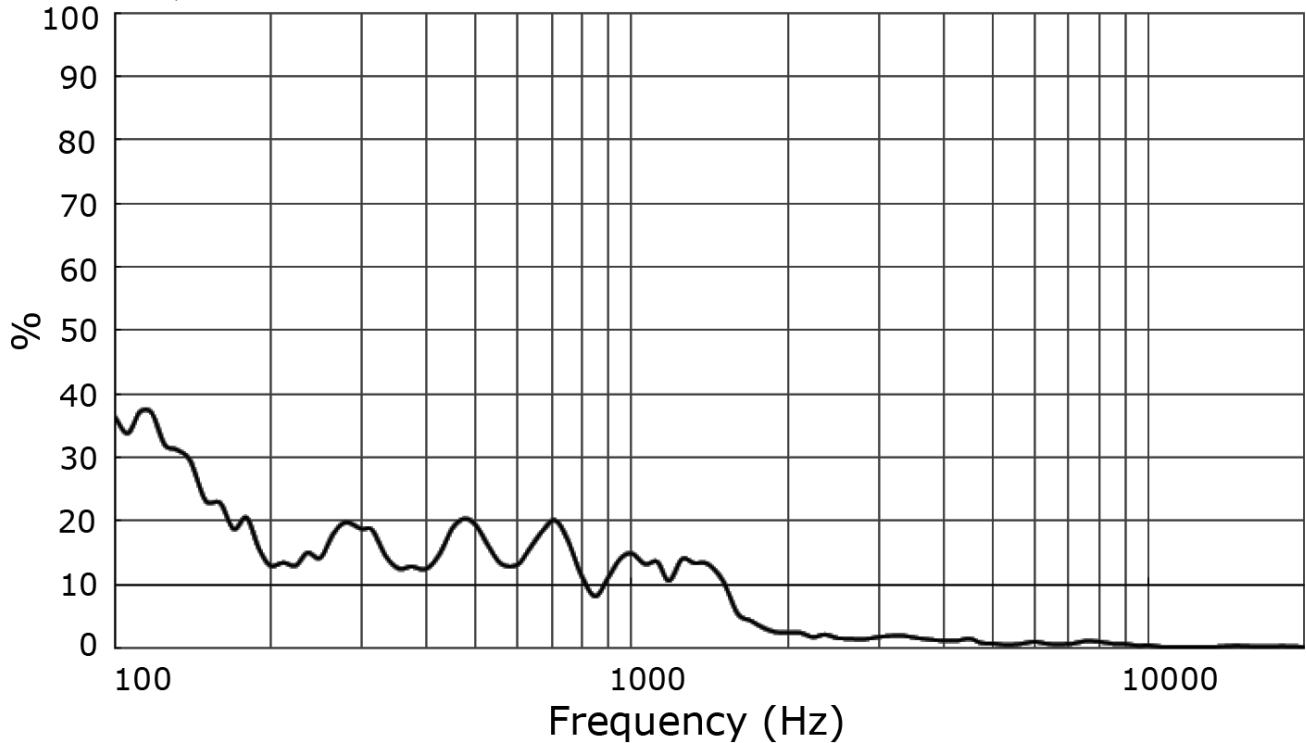

## PACKAGING

units: mm

Tray QTY: 80 pcs per tray  
 Carton Size: 480 x 350 x 450 mm  
 Carton QTY: 2,000 pcs per carton

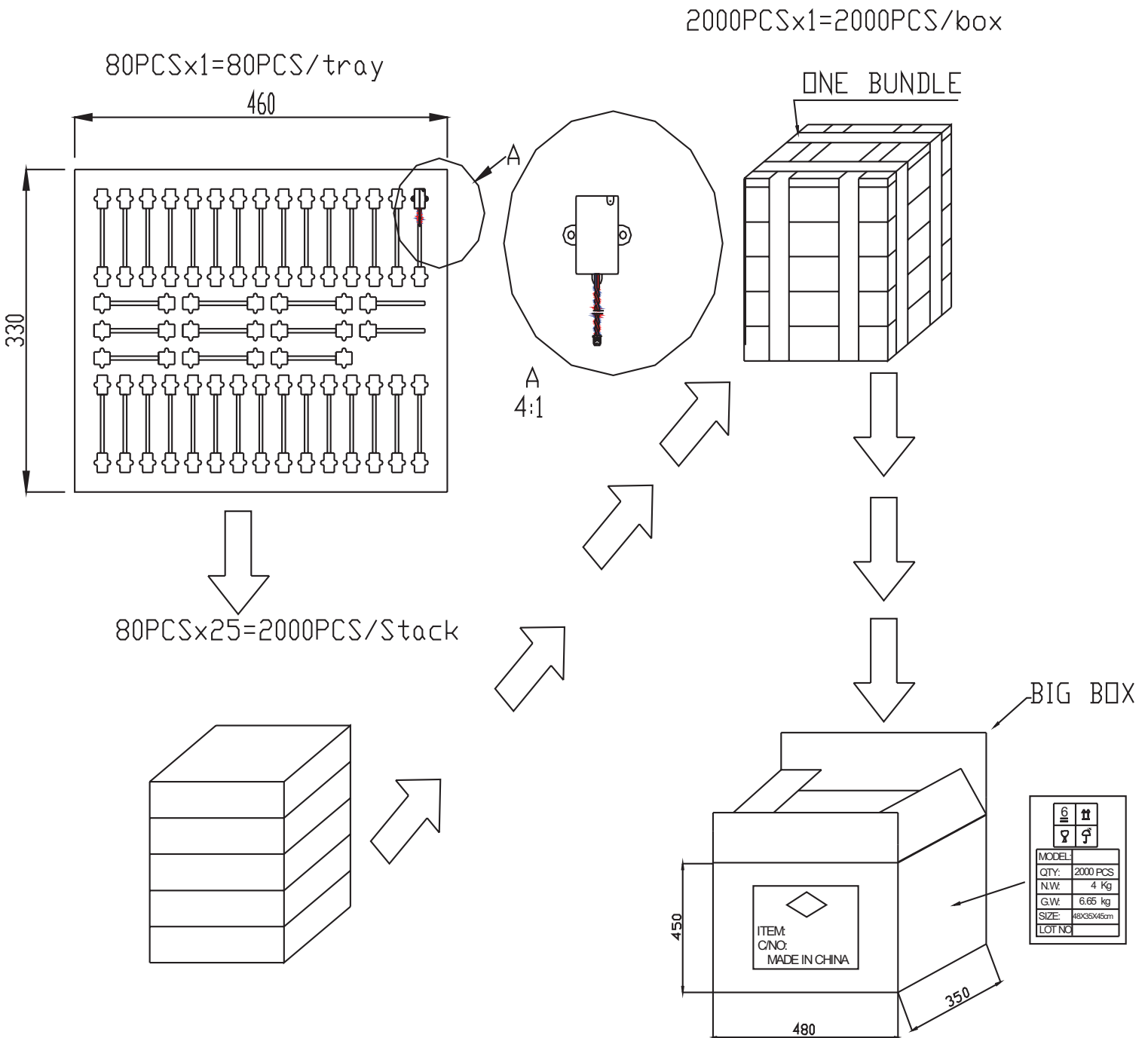

## REVISION HISTORY

rev.	description	date
1.0	initial release	11/07/2019
1.01	added internal speaker details	03/12/2020
1.02	added Molex and JST connector options	10/21/2020
1.03	logo, datasheet style update	08/05/2022
1.04	CUI Devices rebranded to Same Sky	09/11/2024

The revision history provided is for informational purposes only and is believed to be accurate.



Same Sky offers a one (1) year limited warranty. Complete warranty information is listed on our website.

Same Sky reserves the right to make changes to the product at any time without notice. Information provided by Same Sky is believed to be accurate and reliable. However, no responsibility is assumed by Same Sky for its use, nor for any infringements of patents or other rights of third parties which may result from its use.

Same Sky products are not authorized or warranted for use as critical components in equipment that requires an extremely high level of reliability. A critical component is any component of a life support device or system whose failure to perform can be reasonably expected to cause the failure of the life support device or system, or to affect its safety or effectiveness.

[sameskydevices.com](https://www.sameskydevices.com)