



**MODEL:** CEB-2732-L100 | **DESCRIPTION:** PIEZOELECTRIC DIAPHRAGM

**FEATURES**

- 100 mm lead wire
- piezo element
- externally driven



**SPECIFICATIONS**

parameter	conditions/description	min	typ	max	units
operating voltage				30	Vp-p
resonant frequency	only for piezo element without wire	2,950	3,250	3,550	Hz
resonant impedance	only for piezo element without wire			150	$\Omega$
electrostatic capacity	at 120 Hz	18,200	26,000	33,800	pF
dimensions	$\varnothing 27 \times 0.32$				mm
weight			3.0		g
material	stainless steel				
terminal	wire leads				
operating temperature		-20		70	$^{\circ}\text{C}$
storage temperature		-30		80	$^{\circ}\text{C}$
hand soldering		370	380	390	$^{\circ}\text{C}$
RoHS	yes				

**MECHANICAL DRAWING**

units: mm

tolerance:  $\pm 0.5$  mm

wire: UL1571, 32 AWG

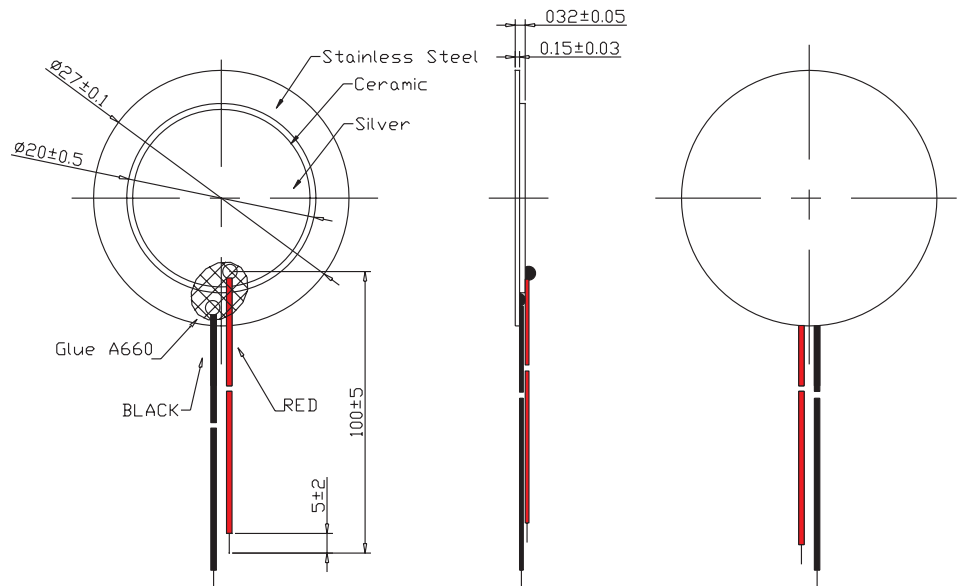

## REVISION HISTORY

rev.	description	date
1.0	initial release	05/13/2024
1.01	CUI Devices rebranded to Same Sky	09/11/2024

The revision history provided is for informational purposes only and is believed to be accurate.



Same Sky offers a one (1) year limited warranty. Complete warranty information is listed on our website.

Same Sky reserves the right to make changes to the product at any time without notice. Information provided by Same Sky is believed to be accurate and reliable. However, no responsibility is assumed by Same Sky for its use, nor for any infringements of patents or other rights of third parties which may result from its use.

Same Sky products are not authorized or warranted for use as critical components in equipment that requires an extremely high level of reliability. A critical component is any component of a life support device or system whose failure to perform can be reasonably expected to cause the failure of the life support device or system, or to affect its safety or effectiveness.

[sameskydevices.com](https://www.sameskydevices.com)