

## Product Change Notice (PCN)

Date: **4/19/2023**

PCN Number: **PCN-0454731R-01**

To Our Customers:

We appreciate your use of our products. Our commitment in maintaining and improving processes is demonstrated by plans to enhance our product quality, reliability, and manufacturability. The purpose of this notice is to inform you of a product change.

Product(s) Affected: SJ-2504A-SMT-TR

Reason(s) for Change: *Manufacturing process improvements*

Description of Change: mechanical, material, packaging, and soldering differences as shown below:

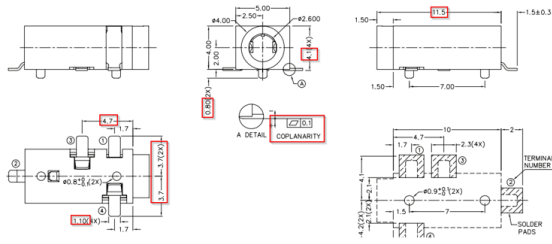
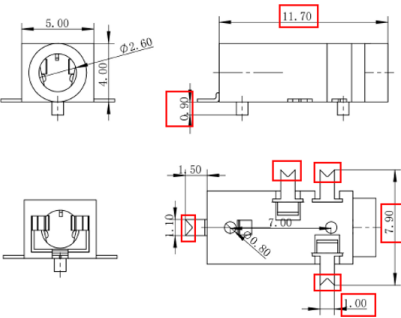
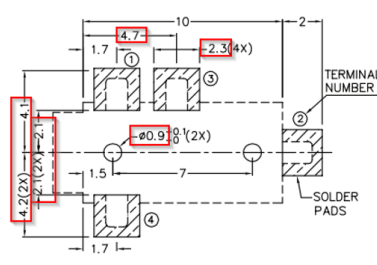
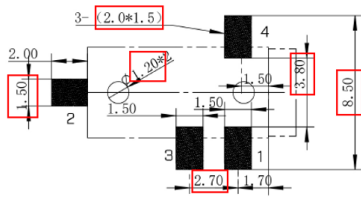
PREVIOUS CUI DEVICES DETAIL / IMAGE	NEW CUI DEVICES DETAIL / IMAGE																																				
																																					
 <p style="text-align: center;">Recommended PCB Layout Top View</p>	 <p style="text-align: center;">Recommended PCB Layout Top View</p>																																				
<table border="1"> <thead> <tr> <th></th> <th>MATERIAL</th> <th>PLATING</th> </tr> </thead> <tbody> <tr> <td>terminal 1</td> <td>copper alloy</td> <td>silver</td> </tr> <tr> <td>terminal 2</td> <td>copper alloy</td> <td>silver</td> </tr> <tr> <td>terminal 3</td> <td>copper alloy</td> <td>silver</td> </tr> <tr> <td>terminal 4</td> <td>copper alloy</td> <td>silver</td> </tr> <tr> <td>plastic</td> <td>PA10T</td> <td></td> </tr> </tbody> </table>		MATERIAL	PLATING	terminal 1	copper alloy	silver	terminal 2	copper alloy	silver	terminal 3	copper alloy	silver	terminal 4	copper alloy	silver	plastic	PA10T		<table border="1"> <thead> <tr> <th>DESCRIPTION</th> <th>MATERIAL</th> <th>PLATING/COLOR</th> </tr> </thead> <tbody> <tr> <td>terminal 1</td> <td>phosphorus bronze</td> <td>silver</td> </tr> <tr> <td>terminal 2</td> <td>phosphorus bronze</td> <td>silver</td> </tr> <tr> <td>terminal 3</td> <td>phosphorus bronze</td> <td>silver</td> </tr> <tr> <td>terminal 4</td> <td>phosphorus bronze</td> <td>silver</td> </tr> <tr> <td>housing</td> <td>PPA [UL94V-0]</td> <td>black</td> </tr> </tbody> </table>	DESCRIPTION	MATERIAL	PLATING/COLOR	terminal 1	phosphorus bronze	silver	terminal 2	phosphorus bronze	silver	terminal 3	phosphorus bronze	silver	terminal 4	phosphorus bronze	silver	housing	PPA [UL94V-0]	black
	MATERIAL	PLATING																																			
terminal 1	copper alloy	silver																																			
terminal 2	copper alloy	silver																																			
terminal 3	copper alloy	silver																																			
terminal 4	copper alloy	silver																																			
plastic	PA10T																																				
DESCRIPTION	MATERIAL	PLATING/COLOR																																			
terminal 1	phosphorus bronze	silver																																			
terminal 2	phosphorus bronze	silver																																			
terminal 3	phosphorus bronze	silver																																			
terminal 4	phosphorus bronze	silver																																			
housing	PPA [UL94V-0]	black																																			

F-723-001

Revision: A

SOLDERABILITY				
parameter	conditions/description	min	typ	max units
reflow storage	at relative humidity <math>< 50\%</math>			400 °C
reflow soldering	see reflow profile	255	280	285 °C
drying conditions	parts in reel bake at 40°C ±5°C for 72 hours parts removed from reel bake at 40°C ±5°C for 10 hours			

Notes:  
 1. Must reflow solder within 72 hours from opening vacuum packaging at a temperature <math>< 50\%</math> relative humidity <math>< 50\%</math>.  
 2. When unloading from file by 172 hours.

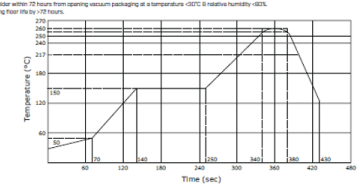

SOLDERABILITY				
parameter	conditions/description	min	typ	max units
reflow storage	10-30°C, <math>< 70\%</math> humidity			
reflow soldering	see reflow profile	255	280	°C
drying conditions	parts in reel bake at 110°C for 4 hours parts removed from reel bake at 110°C for 4 hours			

Notes:  
 1. CuI Devices requirements to solder within 72 hours from opening vacuum packaging at a temperature <math>< 50\%</math> relative humidity <math>< 50\%</math>.  
 2. When unloading from file by 240 hours.

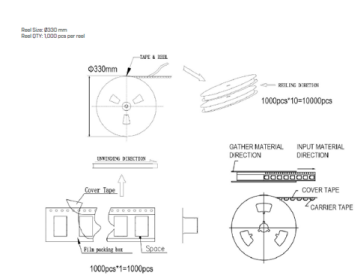
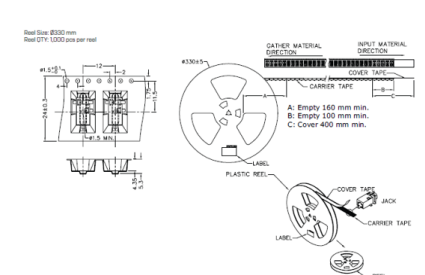
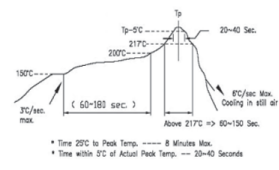

Affected Date Code: 4/12/23

Product Availability: Channel Availability Q2

Additional Information:

PCN Approval:

Operations/Quality



Product Management

