

Product Change Notice (PCN)

Date: **5/4/2023**

PCN Number: **PCN-0450886R-01**

To Our Customers:

We appreciate your use of our products. Our commitment in maintaining and improving processes is demonstrated by plans to enhance our product quality, reliability, and manufacturability. The purpose of this notice is to inform you of a product change.

Product(s) Affected: SJ1-2533-SMT-TR, SJ1-2534-SMT-TR, SJ1-2535-SMT-TR

Reason(s) for Change: *Manufacturing process improvements*

Description of Change: mechanical, material, packaging, and soldering differences as shown below:

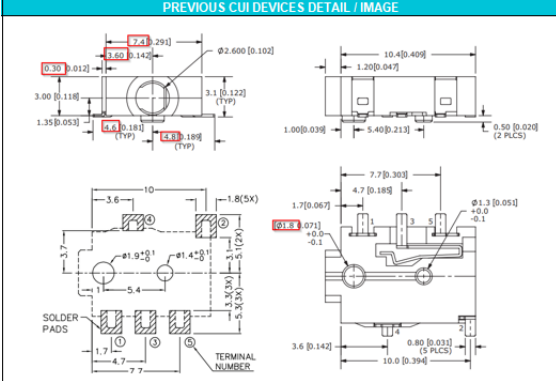
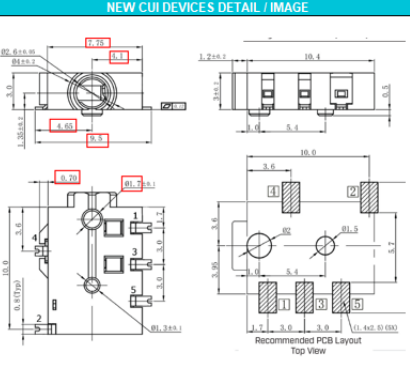
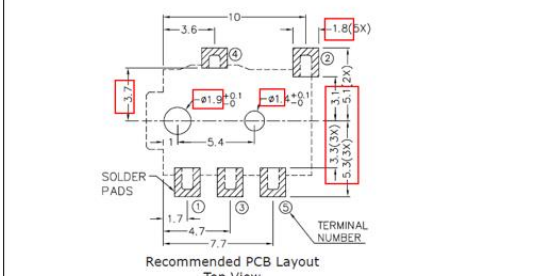
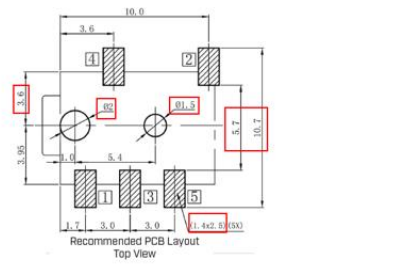
PREVIOUS CUI DEVICES DETAIL / IMAGE	NEW CUI DEVICES DETAIL / IMAGE																																										
																																											
																																											
<table border="1"> <thead> <tr> <th></th> <th>MATERIAL</th> <th>PLATING</th> </tr> </thead> <tbody> <tr> <td>terminal 1</td> <td>copper alloy</td> <td>gold flash</td> </tr> <tr> <td>terminal 2</td> <td>copper alloy</td> <td>gold flash</td> </tr> <tr> <td>terminal 3</td> <td>copper alloy</td> <td>gold flash</td> </tr> <tr> <td>terminal 4</td> <td>brass</td> <td>gold flash</td> </tr> <tr> <td>terminal 5</td> <td>copper alloy</td> <td>gold flash</td> </tr> <tr> <td>plastic</td> <td>PA6T or equivalent</td> <td></td> </tr> </tbody> </table>		MATERIAL	PLATING	terminal 1	copper alloy	gold flash	terminal 2	copper alloy	gold flash	terminal 3	copper alloy	gold flash	terminal 4	brass	gold flash	terminal 5	copper alloy	gold flash	plastic	PA6T or equivalent		<table border="1"> <thead> <tr> <th>DESCRIPTION</th> <th>MATERIAL</th> <th>PLATING/COLOR</th> </tr> </thead> <tbody> <tr> <td>terminal 1</td> <td>copper alloy</td> <td>gold</td> </tr> <tr> <td>terminal 2</td> <td>copper alloy</td> <td>gold</td> </tr> <tr> <td>terminal 3</td> <td>copper alloy</td> <td>gold</td> </tr> <tr> <td>terminal 4</td> <td>copper alloy</td> <td>gold</td> </tr> <tr> <td>terminal 5</td> <td>copper alloy</td> <td>gold</td> </tr> <tr> <td>housing</td> <td>PA9T (LUL94V-0)</td> <td>black</td> </tr> </tbody> </table>	DESCRIPTION	MATERIAL	PLATING/COLOR	terminal 1	copper alloy	gold	terminal 2	copper alloy	gold	terminal 3	copper alloy	gold	terminal 4	copper alloy	gold	terminal 5	copper alloy	gold	housing	PA9T (LUL94V-0)	black
	MATERIAL	PLATING																																									
terminal 1	copper alloy	gold flash																																									
terminal 2	copper alloy	gold flash																																									
terminal 3	copper alloy	gold flash																																									
terminal 4	brass	gold flash																																									
terminal 5	copper alloy	gold flash																																									
plastic	PA6T or equivalent																																										
DESCRIPTION	MATERIAL	PLATING/COLOR																																									
terminal 1	copper alloy	gold																																									
terminal 2	copper alloy	gold																																									
terminal 3	copper alloy	gold																																									
terminal 4	copper alloy	gold																																									
terminal 5	copper alloy	gold																																									
housing	PA9T (LUL94V-0)	black																																									

F-723-001

Revision: A

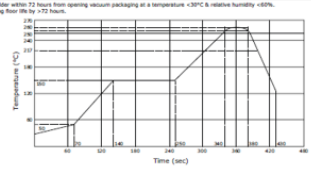
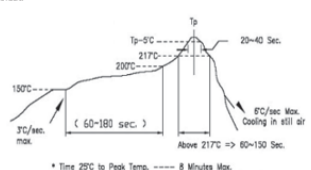
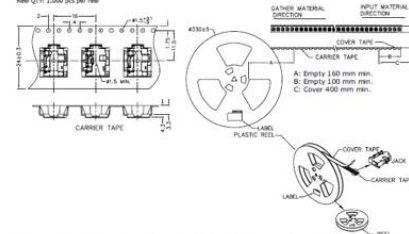
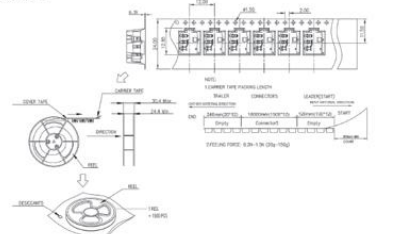
<p>SOLDERABILITY</p> <table border="1"> <thead> <tr> <th>parameter</th> <th>conditions/description</th> <th>min</th> <th>typ</th> <th>max</th> <th>units</th> </tr> </thead> <tbody> <tr> <td>refl storage</td> <td>at relative humidity ~80%</td> <td></td> <td>40</td> <td></td> <td>°C</td> </tr> <tr> <td>reflow soldering¹</td> <td>see reflow profile</td> <td>255</td> <td>260</td> <td>265</td> <td>°C</td> </tr> <tr> <td>drying conditions²</td> <td>parts in reel: bake at 40°C ±5°C for 72 hours parts removed from reel: bake at 40°C ±5°C for 10 hours</td> <td></td> <td></td> <td></td> <td></td> </tr> </tbody> </table> <p>Note: 1. Must reflow solder within 72 hours from opening vacuum packaging at a temperature +35°C & relative humidity <80%. 2. When exceeding four 96h by >32 hours.</p> 		parameter	conditions/description	min	typ	max	units	refl storage	at relative humidity ~80%		40		°C	reflow soldering ¹	see reflow profile	255	260	265	°C	drying conditions ²	parts in reel: bake at 40°C ±5°C for 72 hours parts removed from reel: bake at 40°C ±5°C for 10 hours					<p>SOLDERABILITY</p> <table border="1"> <thead> <tr> <th>parameter</th> <th>conditions/description</th> <th>min</th> <th>typ</th> <th>max</th> <th>units</th> </tr> </thead> <tbody> <tr> <td>refl storage</td> <td>10-30°C <70% humidity</td> <td></td> <td></td> <td></td> <td>°C</td> </tr> <tr> <td>reflow soldering¹</td> <td>see reflow profile</td> <td>255</td> <td>260</td> <td></td> <td>°C</td> </tr> <tr> <td>drying conditions²</td> <td>parts in reel: bake at 110°C for 4 hours parts removed from reel: bake at 110°C for 4 hours</td> <td></td> <td></td> <td></td> <td></td> </tr> </tbody> </table> <p>Note: 1. CU Devices recommends to solder within 72 hours from opening vacuum packaging at a temperature +35°C & relative humidity <80%. 2. When exceeding four 96h by >32 hours.</p>  <ul style="list-style-type: none"> • Time 25°C to Peak Temp. --- 8 Minutes Max. • Time within 5°C of Actual Peak Temp. --- 20-40 Seconds 		parameter	conditions/description	min	typ	max	units	refl storage	10-30°C <70% humidity				°C	reflow soldering ¹	see reflow profile	255	260		°C	drying conditions ²	parts in reel: bake at 110°C for 4 hours parts removed from reel: bake at 110°C for 4 hours				
parameter	conditions/description	min	typ	max	units																																														
refl storage	at relative humidity ~80%		40		°C																																														
reflow soldering ¹	see reflow profile	255	260	265	°C																																														
drying conditions ²	parts in reel: bake at 40°C ±5°C for 72 hours parts removed from reel: bake at 40°C ±5°C for 10 hours																																																		
parameter	conditions/description	min	typ	max	units																																														
refl storage	10-30°C <70% humidity				°C																																														
reflow soldering ¹	see reflow profile	255	260		°C																																														
drying conditions ²	parts in reel: bake at 110°C for 4 hours parts removed from reel: bake at 110°C for 4 hours																																																		
<p>PACKAGING</p> <p>units: mm</p> <p>Reel Size: Ø330 mm Reel QTY: 1,000 pcs per reel</p>  <p>A: Empty 160 mm min. B: Empty 150 mm min. C: Cover 400 mm min.</p>		<p>PACKAGING</p> <p>units: mm</p> <p>Reel Size: Ø330mm Reel QTY: 1,000 pcs per reel</p> 																																																	

Affected Date Code: **5/1/23**

Product Availability: **Channel Availability Q2**

Additional Information:

PCN Approval:

Operations/Quality

Roger D. ...

Product Management

RH