

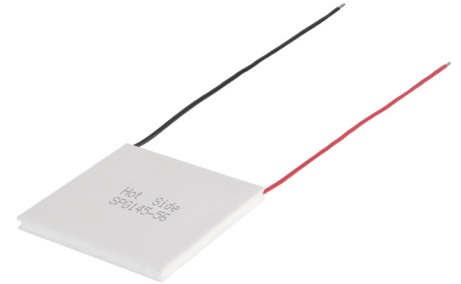

MODEL: SPG145-56 | DESCRIPTION: THERMOELECTRIC GENERATOR

FEATURES

- TEG module
- 14.5 W output
- up to 300°C continuous maximum hot side temp
- silicone sealed
- graphite pad option available



SPECIFICATIONS

parameter	conditions/description	min	typ	max	units
open circuit voltage	at Th = 300°C, Tc = 30°C		9.9		V
matched load resistance	at Th = 300°C, Tc = 30°C		1.67		Ω
matched load output voltage	at Th = 300°C, Tc = 30°C		5.0		V
matched load output current	at Th = 300°C, Tc = 30°C		2.9		A
matched load output power	at Th = 300°C, Tc = 30°C		14.5		W
heat flow across module			247		W
heat flow density			7.9		W/cm ²
ac resistance	at 27 °C, 1000 Hz	0.7		1.0	Ω
solder melting temperature	cold side: SnAgSn solder hot side: no solder, aluminum bonding	217			°C
hot side plate		-60		300	°C
cold side plate		-60		180	°C
assembly compression				1.4	MPa
mounting torque per screw	screw diameter / # of screws: 5 mm / 2		0.3		kg-m
RoHS	yes				

Note: 1. Product available with graphite pad on hot/cold, please inquire with Same Sky sales.

MECHANICAL DRAWING

units: mm

	MATERIAL	PLATING
ceramic plate	96% Al_2O_3	
wire leads	AF250 22 AWG	tin
sealer	BG SIDUN 3.0 (between cold and hot side plates)	
marking	P/N & "HOT SIDE" printed on hot side surface	

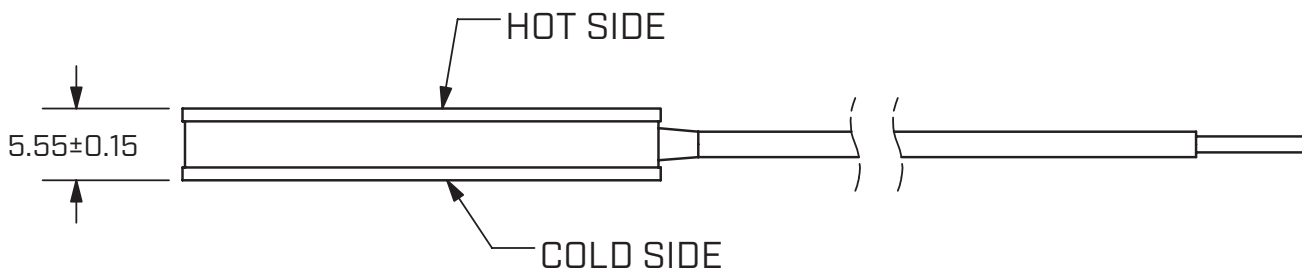
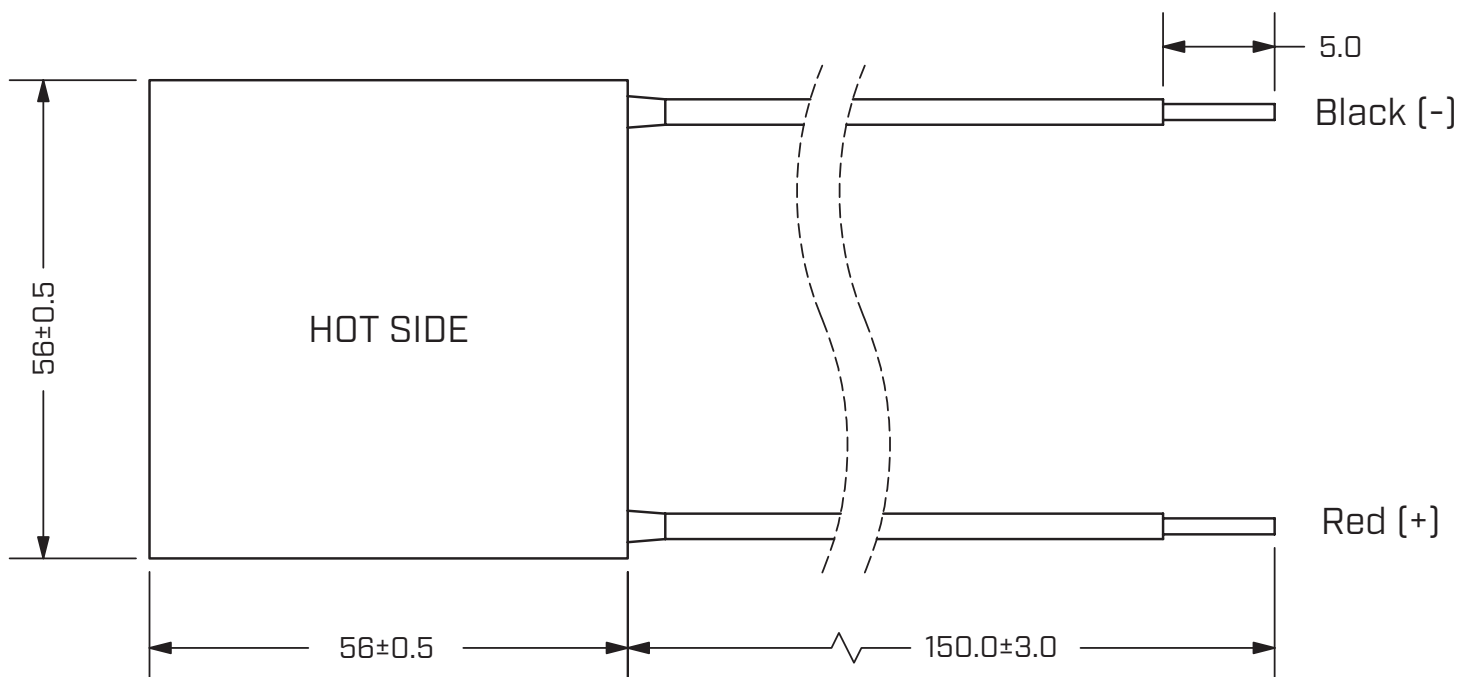

PERFORMANCE CURVES

Open Circuit Voltage Vs. Th

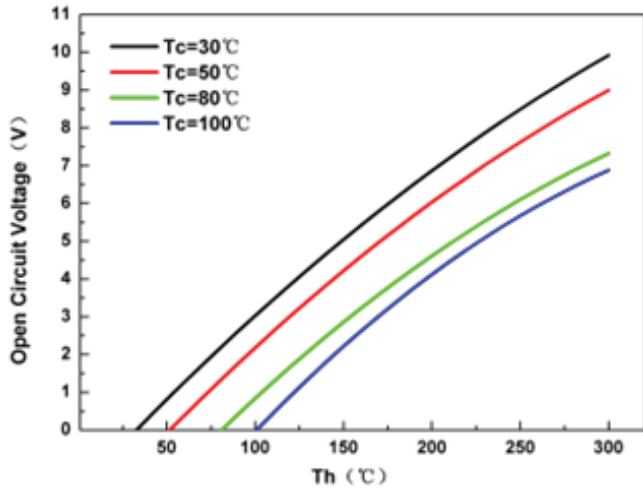

Matched Load Resistance Vs. Th

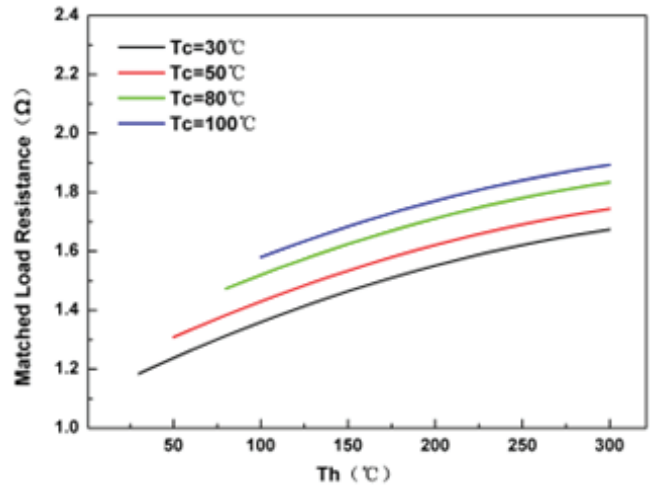

Matched Load Voltage Vs. Th

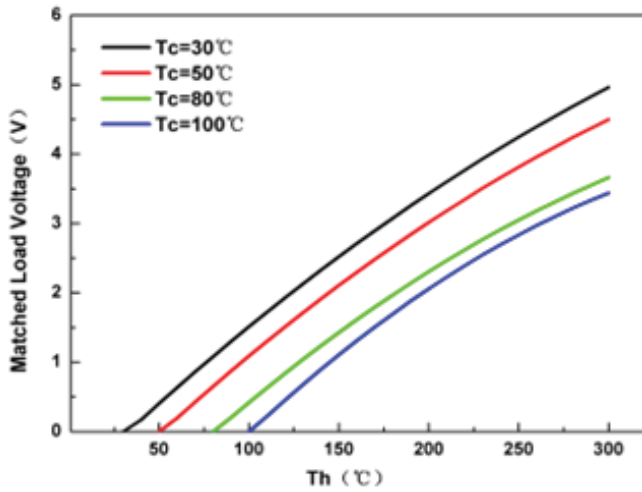

Matched Load Current Vs. Th

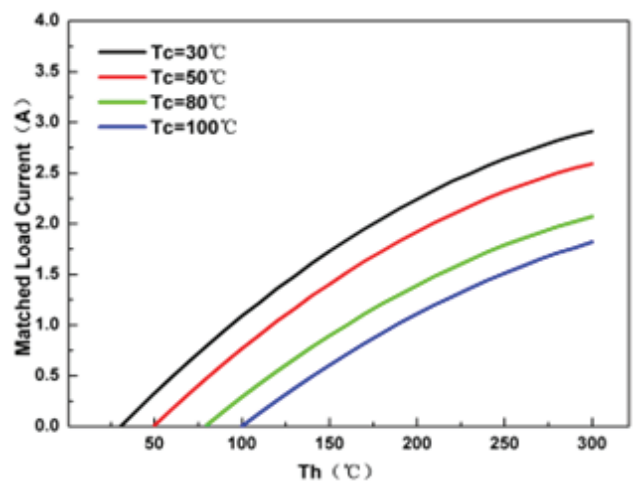

Matched Load Output Power Vs. Th

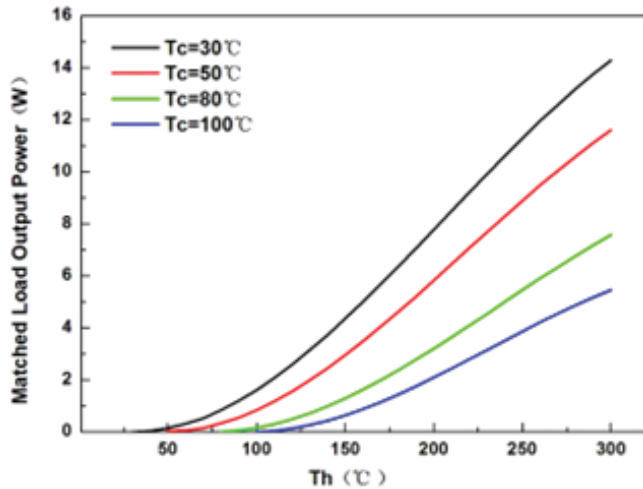

Output Voltage/Power Vs. Output Current ($T_h=300^\circ\text{C}$, $T_c=30^\circ\text{C}$)

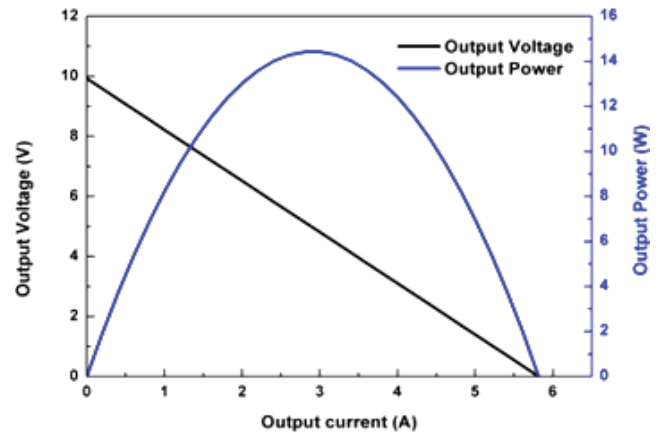

REVISION HISTORY

rev.	description	date
1.0	initial release	11/13/2024

The revision history provided is for informational purposes only and is believed to be accurate.



Same Sky offers a one (1) year limited warranty. Complete warranty information is listed on our website.

Same Sky reserves the right to make changes to the product at any time without notice. Information provided by Same Sky is believed to be accurate and reliable. However, no responsibility is assumed by Same Sky for its use, nor for any infringements of patents or other rights of third parties which may result from its use.

Same Sky products are not authorized or warranted for use as critical components in equipment that requires an extremely high level of reliability. A critical component is any component of a life support device or system whose failure to perform can be reasonably expected to cause the failure of the life support device or system, or to affect its safety or effectiveness.

[sameskydevices.com](https://www.sameskydevices.com)