

MODEL: SIM-1-A | **DESCRIPTION:** SIM CARD CONNECTOR**FEATURES**

- SIM card connector
- push in, auto eject out
- card detect switch
- gold flash
- surface mount
- UL94V-0

**SPECIFICATIONS**

parameter	conditions/description	min	typ	max	units
rated voltage				30	V
rated current				0.5	A
contact resistance ¹				100	mΩ
insulation resistance	at 500 Vdc, between adjacent circuits	1,000			MΩ
voltage withstand	for 1 minute, between adjacent circuits		100		Vac
insertion force	at a rate of 25 mm/min			10	N
withdrawal force	at a rate of 25 mm/min	0.5			N
life			5,000		cycles
operating temperature		-40		85	°C
flammability rating	UL94V-0				
RoHS	yes				

Note: 1. When measured at 20 mV / 100 mA.

SOLDERABILITY

parameter	conditions/description	min	typ	max	units
reel storage	at relative humidity 40-70% reel opened: use within 1 month reel unopened: up to 15 month shelf life	16	22	28	°C
reflow soldering	see reflow profile			250	°C

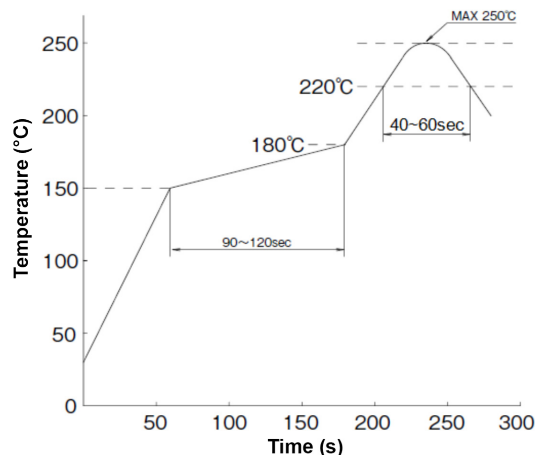

MECHANICAL DRAWING

units: mm
 tolerance:
 X.X ±0.30 mm
 X.XX ±0.20 mm
 X.XXX ±0.10 mm
 unless otherwise specified

DESCRIPTION	MATERIAL	PLATING/COLOR
housing	LCP 30% GF (UL94-0)	black
contact terminals	phosphor bronze t=0.15 mm	contact area: gold flash over nickel solder area: tin over nickel /CD2 gold flash over nickel
cover	SUS304 t=0.2 mm	solder area: gold flash over nickel

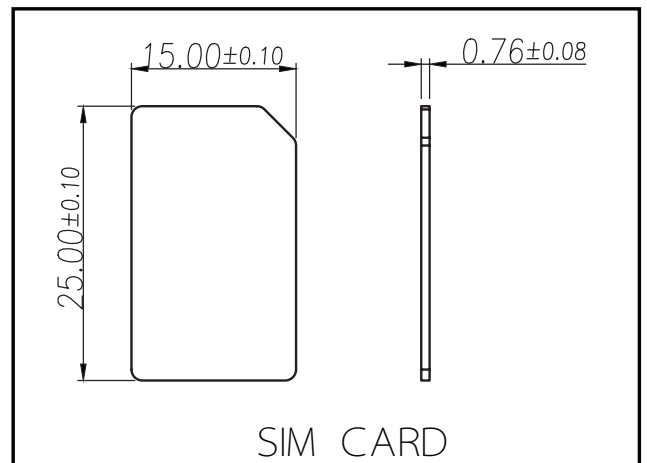
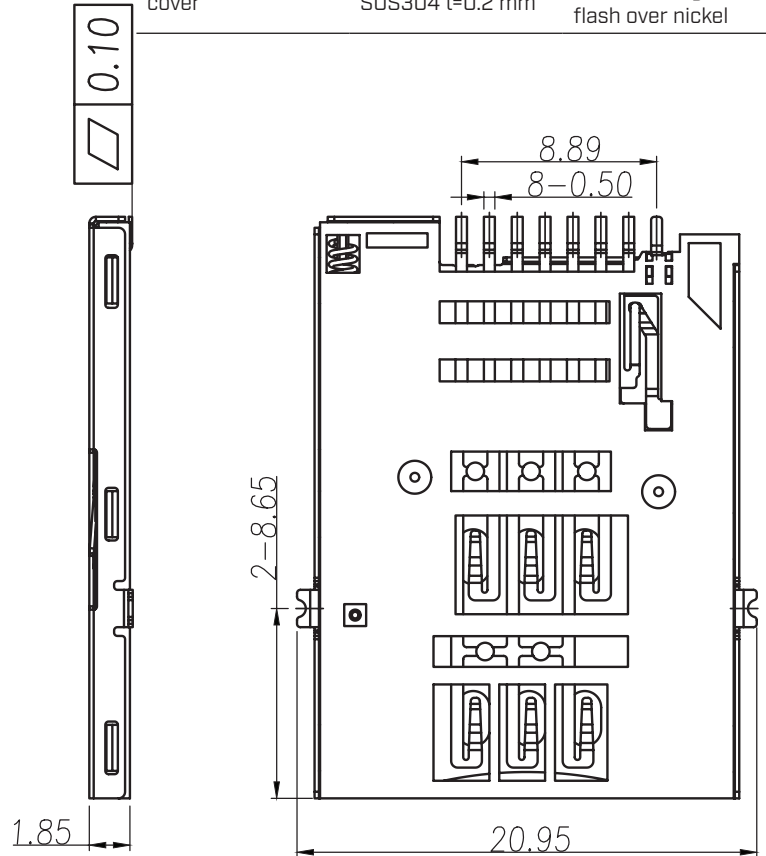
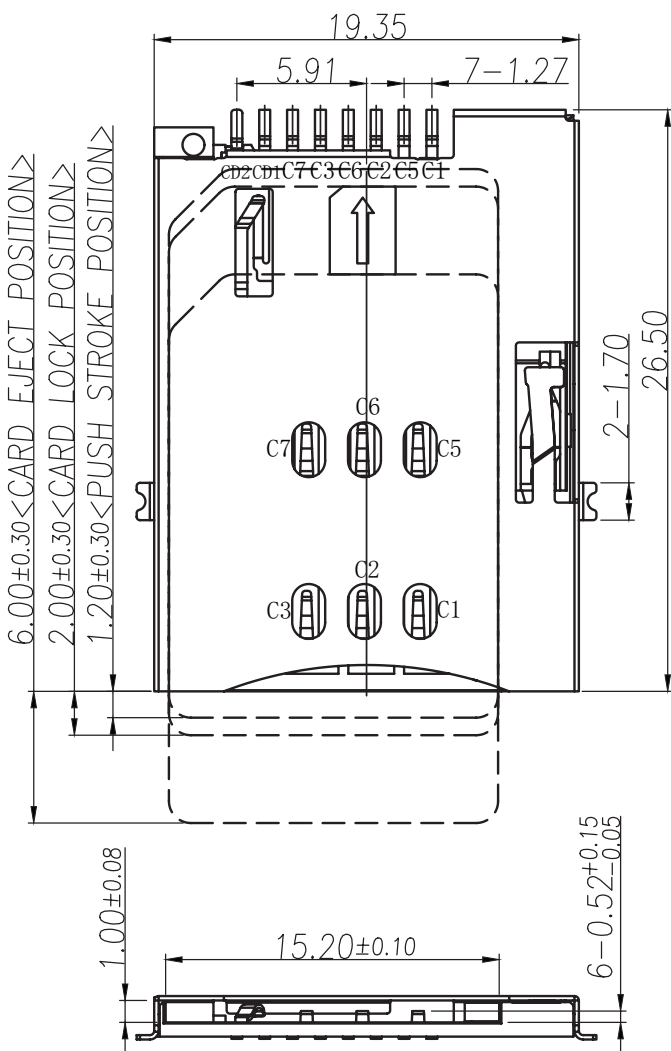

MECHANICAL DRAWING (CONTINUED)

units: mm
PCB tolerance: ±0.05 mm

PIN CONNECTIONS		
PIN	SIGNAL NAME	DESCRIPTION
C1	VCC	SUPPLY VOLTAGE
C2	RST	RESETTING
C3	CLK	CLOCK
C5	GND	GROUND
C6	VPP	PROGRAMMING VOLTAGE
C7	I/O	DATA LINE
CD1	-	CARD DETECT SWITCH
CD2	-	CARD DETECT SWITCH

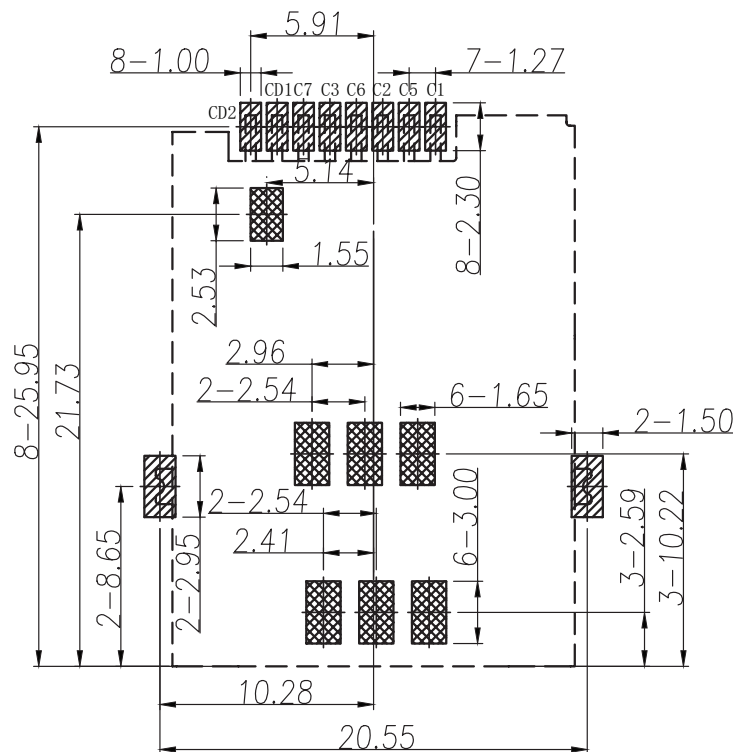
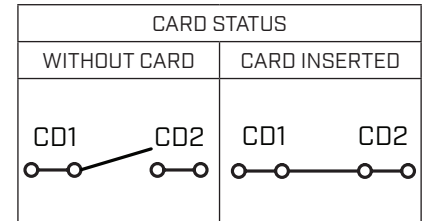

- SMT SOLDER AREA
 - COPPER RESTRICTED AREA
 1. TOUCH AREA OF CONTACT TIPS NO ELECTRICAL FUNCTION
 2. NO FIRST PCB_LAYOUT CIRCUITS IN THE AREA
- Recommended PCB Layout
Top View

PACKAGING

units: mm

Reel Size: $\varnothing 330$ mm

Reel QTY: 550 pcs per reel

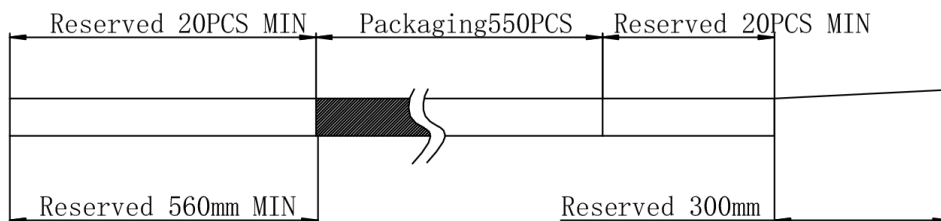
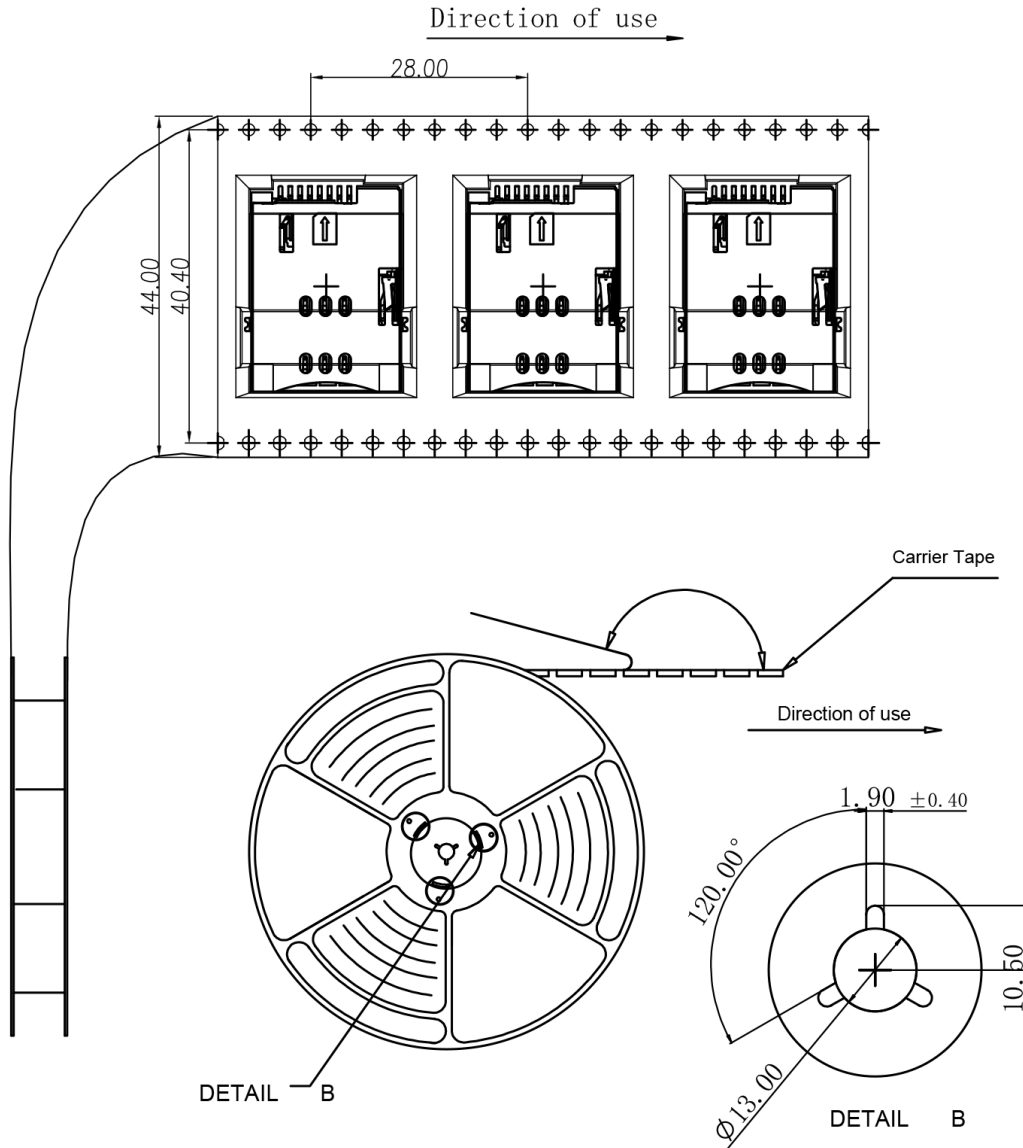

REVISION HISTORY

rev.	description	date
1.0	initial release	10/23/2023
1.01	CUI Devices rebranded to Same Sky	09/12/2024

The revision history provided is for informational purposes only and is believed to be accurate.



Same Sky offers a one (1) year limited warranty. Complete warranty information is listed on our website.

Same Sky reserves the right to make changes to the product at any time without notice. Information provided by Same Sky is believed to be accurate and reliable. However, no responsibility is assumed by Same Sky for its use, nor for any infringements of patents or other rights of third parties which may result from its use.

Same Sky products are not authorized or warranted for use as critical components in equipment that requires an extremely high level of reliability. A critical component is any component of a life support device or system whose failure to perform can be reasonably expected to cause the failure of the life support device or system, or to affect its safety or effectiveness.

[sameskydevices.com](https://www.sameskydevices.com)