



SERIES: RDS-1055-SMT | **DESCRIPTION:** ROTARY DIP SWITCH

FEATURES

- 10 and 16 positions
- flat actuator
- gold plated terminals
- surface mount
- tube or tape and reel packaging



SPECIFICATIONS

parameter	conditions/description	min	typ	max	units
rated voltage	switching			24	Vdc
	non-switching			50	Vdc
rated current	switching			25	mA
	non-switching			100	mA
withstanding voltage	for 1 minute		250		Vac
contact resistance	initial			50	mΩ
	after life test			100	mΩ
insulation resistance	at 250 Vdc	100			MΩ
operating torque				500	gf*cm
dial travel	continuous rotation		360		degrees
operating temperature		-40		85	°C
storage temperature		-40		85	°C
life		10,000			steps
flammability rating	UL94V-0				
RoHS	yes				

PART NUMBER KEY

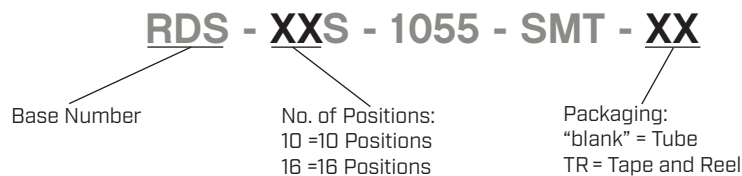

MECHANICAL DRAWING

units: mm

tolerance:

$X \leq 0.5: \pm 0.25$ mm

$0.5 < X \leq 3.0: \pm 0.15$ mm

$3.0 < X \leq 6.0: \pm 0.20$ mm

$6.0 < X \leq 30.0: \pm 0.25$ mm

$30.0 < X \leq 120.0: \pm 0.30$ mm

$120.0 < X \leq 400.0: \pm 0.50$ mm

$X > 400.0: \pm 0.80$ mm

unless otherwise noted

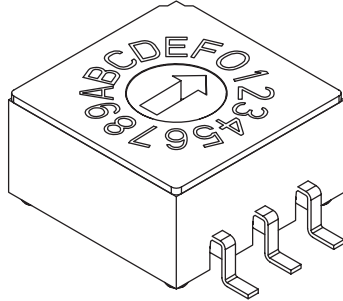

ITEM	DESCRIPTION	MATERIAL	PLATING/COLOR
1	dial	PA9T [UL94V-0]	gray
2	housing	PA9T [UL94V-0]	black
3	base	PA9T [UL94V-0]	black
4	terminals	copper alloy	gold

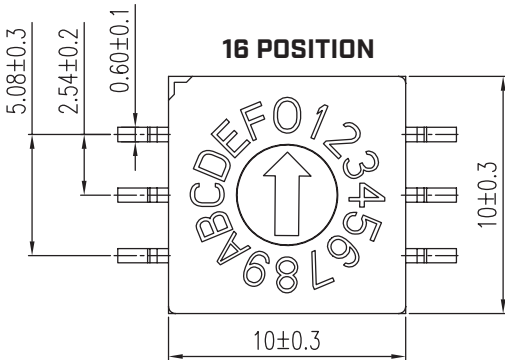
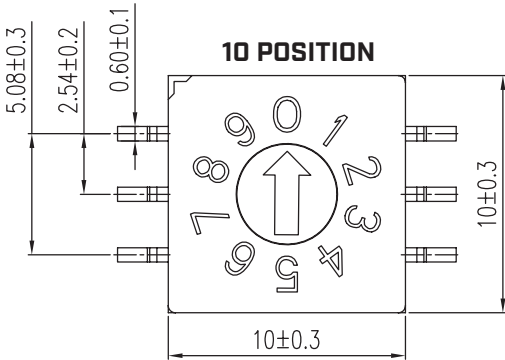

		ON ○				
		OFF ●	CODE			
TYPE		POS	1	2	4	8
10 STEP	0	●	●	●	●	●
	1	○	●	●	●	●
	2	●	○	●	●	●
	3	○	○	●	●	●
	4	●	●	○	●	●
	5	○	●	○	●	●
	6	●	○	○	●	●
	7	○	○	○	●	●
	8	●	●	●	●	○
	9	○	●	●	●	○
16 STEP	A	●	○	●	○	○
	B	○	○	●	○	○
	C	●	●	○	○	○
	D	○	●	○	○	○
	E	●	○	○	○	○
	F	○	○	○	○	○

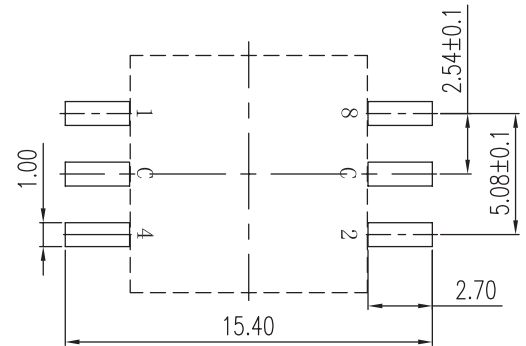
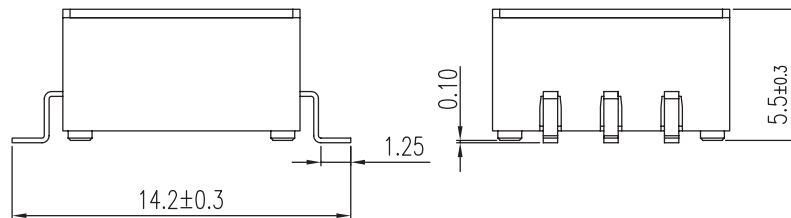

Recommended PCB Layout
Top View

SOLDERABILITY

parameter	conditions/description	min	typ	max	units
hand soldering	for maximum 3 seconds	315	320	325	°C
reflow soldering ¹	240-260 °C (20 seconds max)			260	°C

Notes: 1. It is recommended to reflow solder within 6 months.

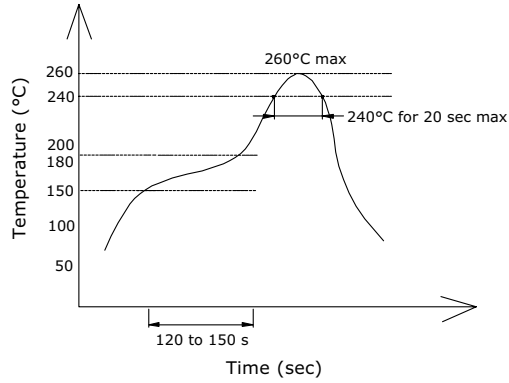

PACKAGING (TUBE)

units: mm

Tube Size: 17.50 x 12.50 x 500 mm

Tube QTY: 47 pcs

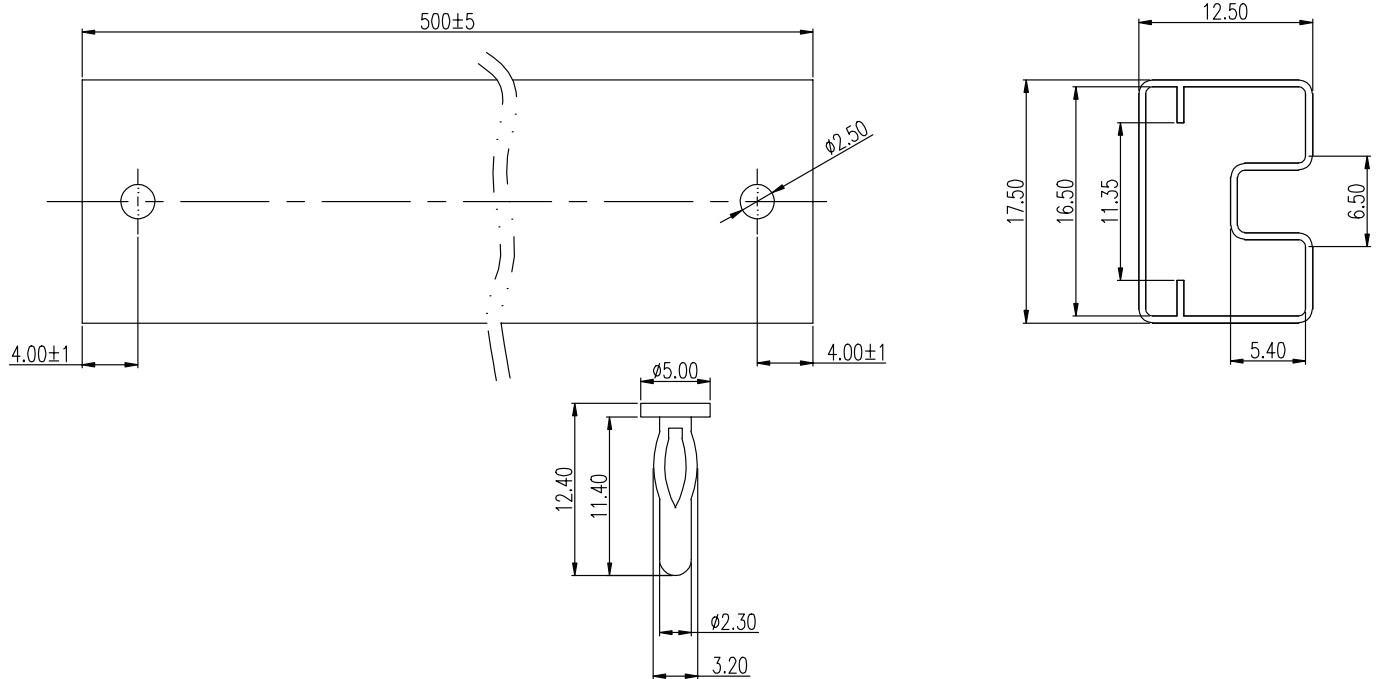

REVISION HISTORY

rev.	description	date
1.0	initial release	05/21/2020
1.01	logo, datasheet style update	08/05/2022
1.02	CUI Devices rebranded to Same Sky	09/12/2024

The revision history provided is for informational purposes only and is believed to be accurate.



Same Sky offers a one (1) year limited warranty. Complete warranty information is listed on our website.

Same Sky reserves the right to make changes to the product at any time without notice. Information provided by Same Sky is believed to be accurate and reliable. However, no responsibility is assumed by Same Sky for its use, nor for any infringements of patents or other rights of third parties which may result from its use.

Same Sky products are not authorized or warranted for use as critical components in equipment that requires an extremely high level of reliability. A critical component is any component of a life support device or system whose failure to perform can be reasonably expected to cause the failure of the life support device or system, or to affect its safety or effectiveness.

[sameskydevices.com](https://www.sameskydevices.com)