



SERIES: PS02 | DESCRIPTION: PRESSURE SENSOR

FEATURES

- temperature compensated
- multiple pressure range options
- absolute, gauge and sealed pressure options
- stainless steel housing
- o-ring seal
- digital output



SPECIFICATIONS

parameter	conditions/description	min	typ	max	units
pressure range	see Pressure Specifications for more details	0		6	MPa
pressure reference	gauge pressure, absolute pressure, sealed gauge pressure				
excitation		3.1	3.3	3.6	V
current consumption	standby current working current			0.1 3	mA mA
output signal	I ² C (14 bit)				
I ² C slave address	0x060				
data ready time				2	ms
response time				3	ms
zero output	at 10% - 90%		666		C hex
span output	at 10% - 90%		3,999		C hex
insulation resistance	at 250 Vdc	200			MΩ
vibration	20 G (20-5,000 Hz)				
shock	100 G for 10 ms				
compensated temperature	<100 kPa models all other models	0 -20		60 85	°C °C
operating temperature		-40		105	°C
storage temperature		-40		125	°C
life			1,000,000		cycles
RoHS	yes				

MECHANICAL

parameter	conditions/description	min	typ	max	units
measured medium	all 316L compatible liquids and gases				
housing/diaphragm	stainless steel 316L				
dimensions	Ø19 x 14				mm
weight		19		25	g

BASIC PARAMETERS

parameter	conditions/description	min	typ	max	units
accuracy ¹			±0.5		%FS
hysteresis			±0.05	±0.1	%FS
repeatability			±0.05	±0.1	%FS
zero temperature drift ¹			±1.0	±1.5	%FS
span temperature drift ¹			±1.0	±1.5	%FS
thermal hysteresis			±0.05	±0.2	%FS
long term stability			±0.25		%FS/year

Note: 1. In the compensation temperature range, refer to 25°C.

PRESSURE SPECIFICATIONS

pressure range	pressure reference ²	overload pressure	burst pressure
0~35 kPa	G	300%FS	400%FS
0~100 kPa	G, A	200%FS	300%FS
0~250 kPa	G	200%FS	300%FS
0~600 kPa	G	200%FS	300%FS
0~1.0 MPa	G	200%FS	300%FS
0~1.6 MPa	G, S	200%FS	300%FS
0~2.5 MPa	G, S	200%FS	300%FS
0~4.0 MPa	S	200%FS	300%FS
0~6.0 MPa	S	200%FS	300%FS

Note: 2. A=absolute pressure (vacuum is zero); G=gauge pressure (current atmospheric pressure as zero); S=sealed gauge pressure (calibrated atmospheric pressure is zero).

PART NUMBER KEY

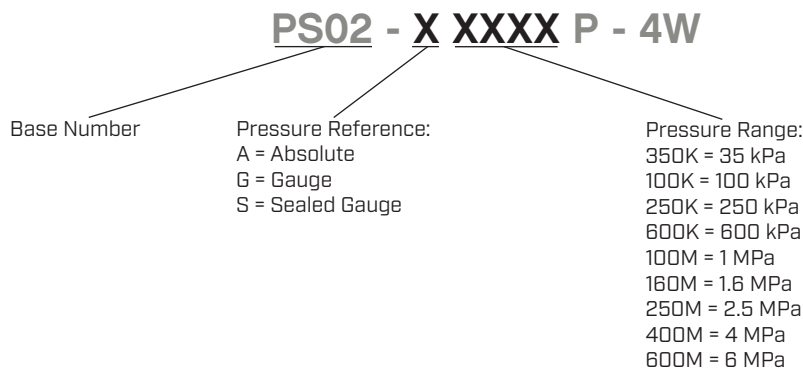

MECHANICAL DRAWING

units: mm
 tolerance: ± 0.1 mm
 unless otherwise noted

ITEM	DESCRIPTION	MATERIAL	PLATING/COLOR
A	housing	SS 316L	
B	diaphragm	SS 316L	
C	oil filling	silicon oil	
D	o-ring	NBR	black
E	wires	silicon; OD: 1.4 mm; 0.15 mm ²	

WIRE CONNECTIONS	
Wire Color	Function
Red	VDD
Blue	GND
Yellow	SCL
White	SDA

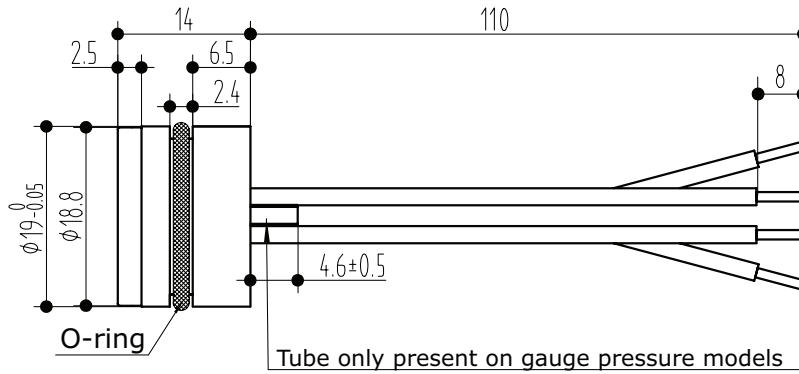

INTERFACE DIAGRAM

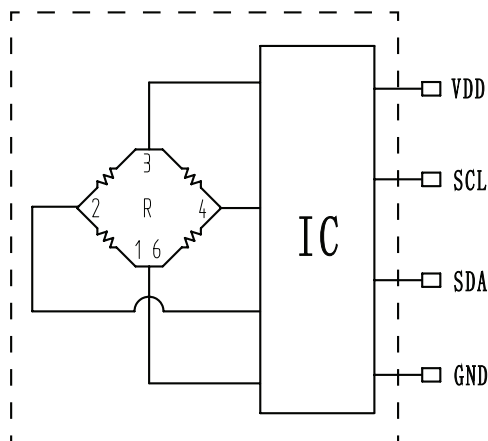

I²C OPERATION

Command Request

I²C slave address: 0x06D

Pressure Command: 0x06

Temperature Command: 0x09

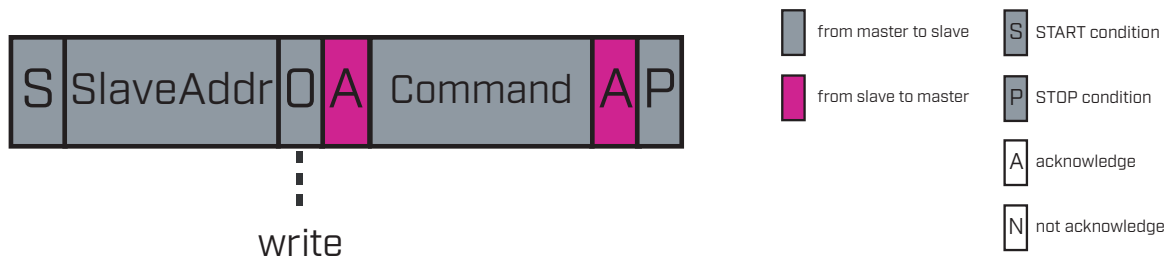

Read Data

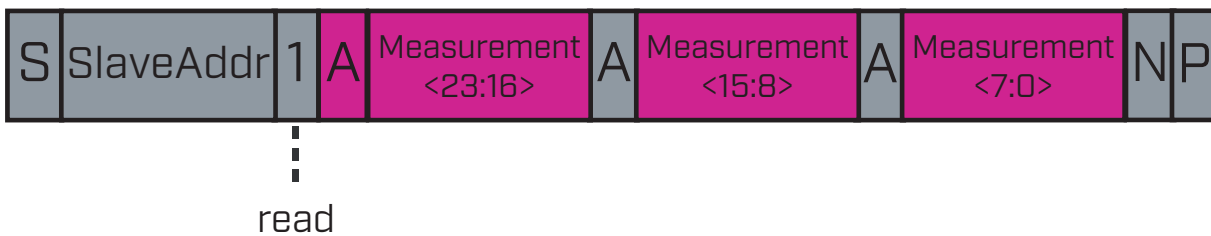

Steps to read data from PS02 sensor

1. Write the corresponding command to the sensor (0x06 for pressure, 0x09 for temperature).
2. Read three bytes from the sensor.
3. Combine these three bytes into a single 24-bit value.
4. Convert the 24-bit value to a standard pressure or temperature unit using the formulas below.

Convert Pressure Value

$$\text{Pressure (kPa)} = P_{\text{max}} / 0.8 * (x / 2^{23} - 0.1)$$

Convert Temperature Value

$$\text{For } x < 2^{23}: \text{Temperature } (^{\circ}\text{C}) = x / 2^{16} + 25$$

$$\text{For } x \geq 2^{23}: \text{Temperature } (^{\circ}\text{C}) = [x - 2^{24}] / 2^{16} + 25$$

I²C TIMING CHARACTERISTICS

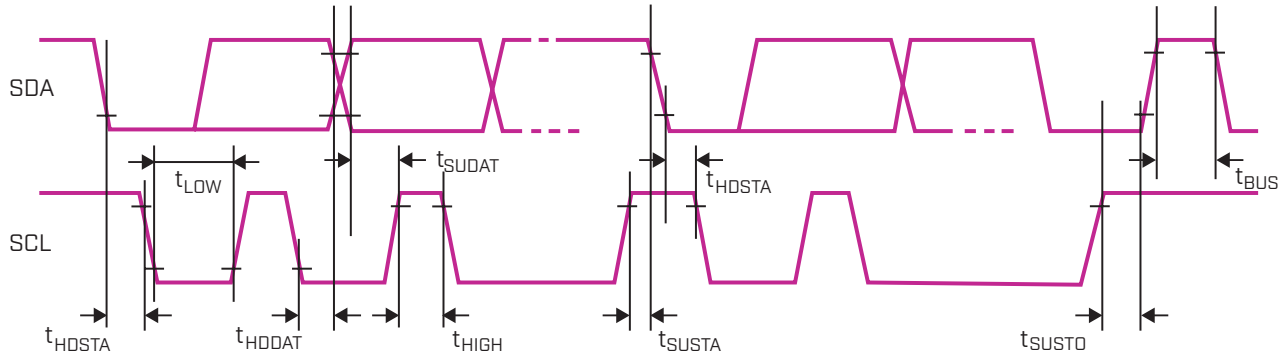

Specification	Symbol	Min	Typical	Max	Unit
SCL clock frequency	f _{SCL}	100	--	400	kHz
Start condition hold time relative to SCL edge	t _{HDSTA}	--	0.6	--	μs
Minimum SCL clock low width	t _{LOW}	--	1.3	--	μs
Minimum SCL clock high width	t _{HIGH}	--	0.6	--	μs
Start condition setup time relative to SCL edge	t _{SUSTA}	--	0.6	--	μs
Data hold time on SDA relative to SCL edge	t _{HDDAT}	--	0.6	--	μs
Data setup time on SDA relative to SCL edge	t _{SUDAT}	--	0.1	--	μs
Stop condition setup time on SCL	t _{SUSTO}	--	0.6	--	μs
Bus free time between stop condition and start condition	t _{BUS}	--	1.3	--	μs

PRESSURE TRANSFER FUNCTION

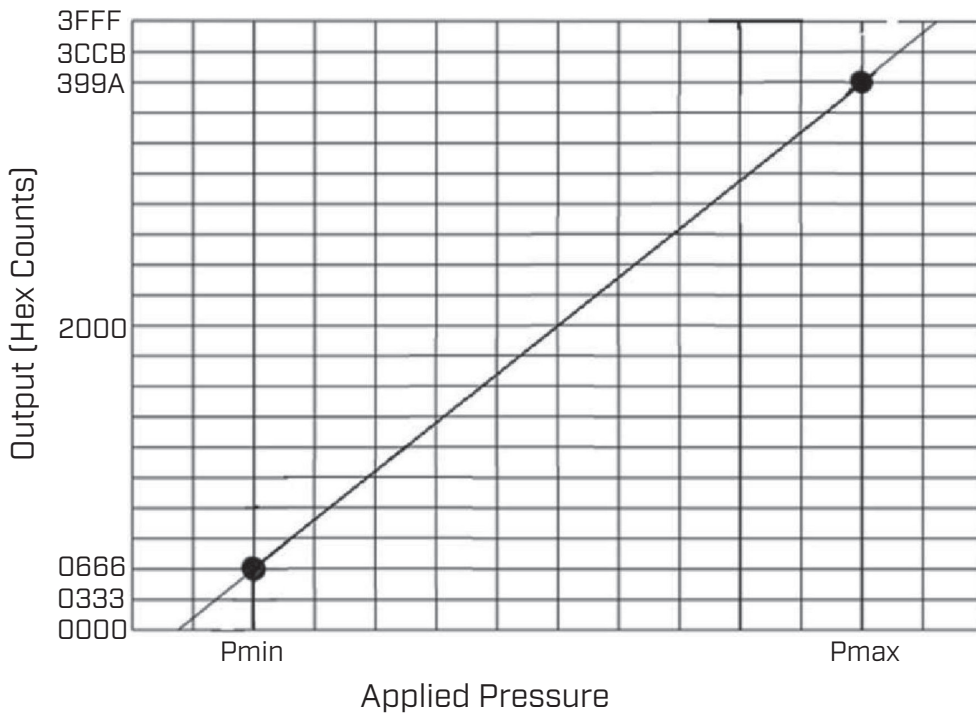

Output (%)	Decimal (D)	Hexadecimal (H)
0	0	0x0000
5	819	0x0333
10	1638	0x0666
50	8192	0x2000
90	14746	0x399A
95	15563	0x3CCB
100	16383	0x3FFF

USAGE CONSIDERATIONS

1. Do not touch the diaphragm with hard objects, which may cause damage to the diaphragm.
2. Strictly follow the wiring method, otherwise it may cause product damage or other potential faults.
3. Misuse of the product may cause danger or personal injury.
4. Pressure range can be selected higher or lower than actual conditions, but should be within $\pm 30\%FS$.
5. Pressure reference consists of gauge pressure, absolute pressure, and sealed gauge pressure.
 - a. Gauge pressure is based on the current atmospheric pressure. Generally, it refers to the measurement of pressure which is greater than the current atmospheric pressure. Negative pressure is a special case of gauge pressure. It refers that there is such working condition that the pressure of work site is lower than the current atmospheric pressure.
 - b. Absolute pressure is based on vacuum.
 - c. Sealed gauge pressure uses absolute pressure die for gauge pressure product based on the atmospheric pressure of production site.
6. Confirm the maximum overload of the applied system, which should be less than the overload protection limit of the sensor, otherwise it will affect the product life or even damage the product.
7. The material and process for manufacturing negative pressure sensors are different from those of positive pressure sensors. So, gauge pressure sensors cannot be used as substitute of negative pressure sensors.

REVISION HISTORY

rev.	description	date
1.0	initial release	12/14/2021
1.01	updated drawing	06/13/2022
1.02	logo, datasheet style update	08/05/2022
1.03	added I ² C details	12/12/2023
1.04	CUI Devices rebranded to Same Sky	09/12/2024

The revision history provided is for informational purposes only and is believed to be accurate.



Same Sky offers a one (1) year limited warranty. Complete warranty information is listed on our website.

Same Sky reserves the right to make changes to the product at any time without notice. Information provided by Same Sky is believed to be accurate and reliable. However, no responsibility is assumed by Same Sky for its use, nor for any infringements of patents or other rights of third parties which may result from its use.

Same Sky products are not authorized or warranted for use as critical components in equipment that requires an extremely high level of reliability. A critical component is any component of a life support device or system whose failure to perform can be reasonably expected to cause the failure of the life support device or system, or to affect its safety or effectiveness.

[sameskydevices.com](https://www.sameskydevices.com)