

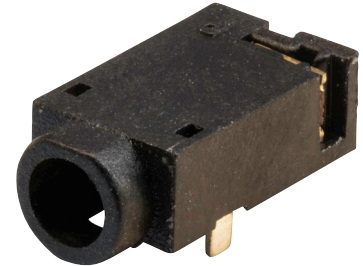

MODEL: PJ-041-SMT-TR | **DESCRIPTION:** DC POWER JACK

FEATURES

- 0.65 mm center pin
- 1.0 A rating
- right angle orientation
- surface mount (SMT)



SPECIFICATIONS

parameter	conditions/description	min	typ	max	units
rated input voltage			24		Vdc
rated input current				1.0	A
contact resistance				30	mΩ
insulation resistance	at 500 Vdc	100			MΩ
voltage withstand	for 1 minute			500	Vac
insertion/withdrawal force		0.3		3	kg
operating temperature		-25		85	°C
life			5,000		cycles
flammability rating	UL94V-0				
RoHS	yes				

SOLDERABILITY

parameter	conditions/description	min	typ	max	units
reel storage	at relative humidity <80%			40	°C
reflow soldering ¹	see reflow profile	255	260	265	°C
drying conditions ²	parts in reel: bake at 40°C ±5°C for 72 hours parts removed from reel: bake at 40°C ±5°C for 10 hours				

Note: 1. Same Sky recommends to solder within 72 hours from opening vacuum packaging at a temperature <30°C & relative humidity <80%.
2. When exceeding floor life by >72 hours.

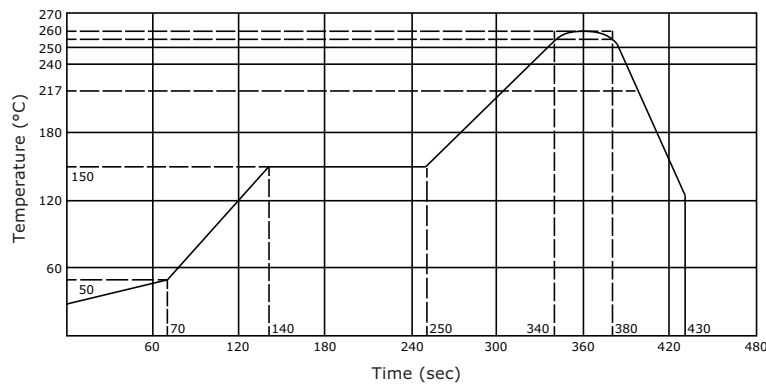

MECHANICAL DRAWING

units: mm
 tolerance:
 X, ±0.50 mm
 X.X ±0.30 mm
 X.XX ±0.20 mm
 X.XXX ±0.10 mm
 PCB: ±0.05 mm
 unless otherwise specified

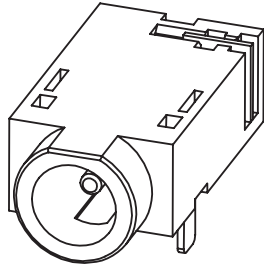

DESCRIPTION	MATERIAL	PLATING/COLOR
center pin	bronze	silver
terminal 1	bronze	silver
terminal 2	SUS301 t=0.20	gold
terminal 3	SUS301 t=0.20	gold
housing	PA10T (UL94V-0)	black

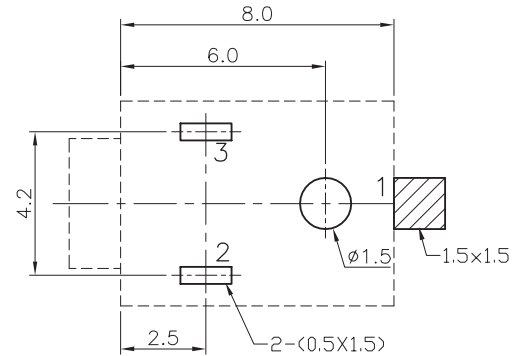
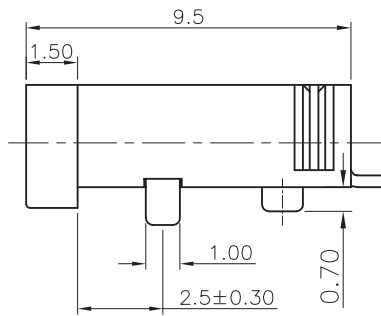
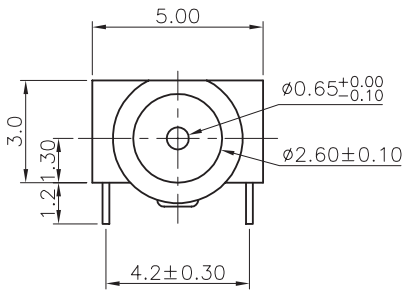
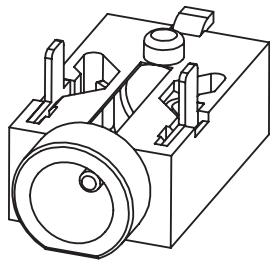

Recommended PCB Layout
Top View

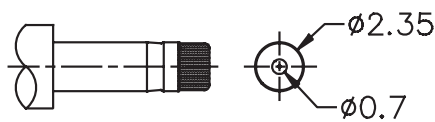
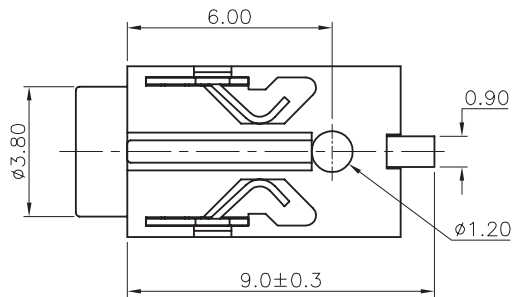

MATING PLUG
Jack Insertion Depth: 7.55 mm

SCHEMATIC	
Model	PJ-041-SMT
Center Pin	Ø0.65 mm

PACKAGING

units: mm

Reel Size: $\varnothing 330$ mm
 Reel QTY: 1,000 pcs per reel

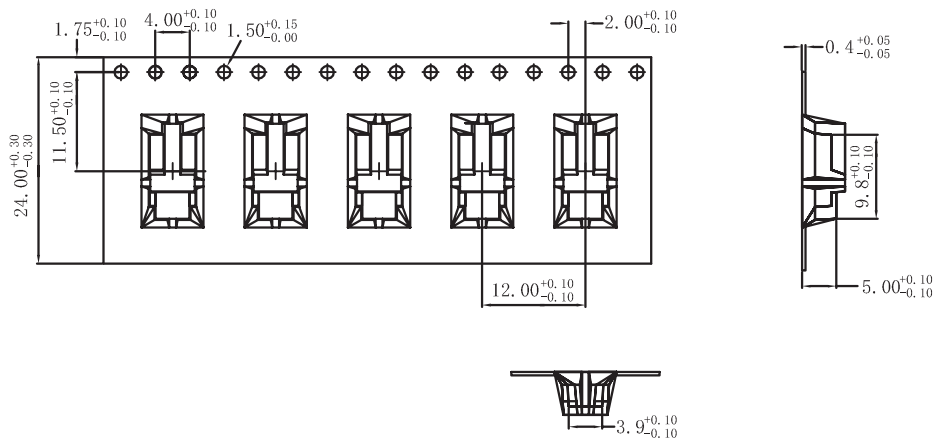
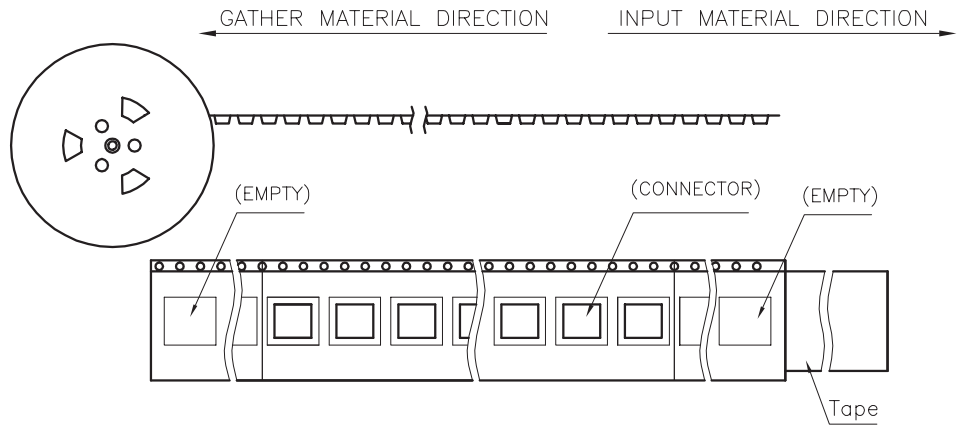

DIMENSIONS:
 33*3.6

1000pcs/reel

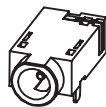

REVISION HISTORY

rev.	description	date
1.0	initial release	02/05/2007
1.01	added TR package option	06/19/2013
1.02	applied new spec template	08/29/2013
1.03	increased voltage rating	04/14/2016
1.04	added storage and drying conditions, and tape and reel packaging details	08/29/2017
1.05	brand update	10/21/2019
1.06	logo, datasheet style update	08/05/2022
1.07	product reengineered for improved manufacturability and production yield, see PCN for details	12/12/2022
1.08	added tape and reel details	08/29/2023
1.09	CUI Devices rebranded to Same Sky	09/12/2024

The revision history provided is for informational purposes only and is believed to be accurate.



Same Sky offers a one (1) year limited warranty. Complete warranty information is listed on our website.

Same Sky reserves the right to make changes to the product at any time without notice. Information provided by Same Sky is believed to be accurate and reliable. However, no responsibility is assumed by Same Sky for its use, nor for any infringements of patents or other rights of third parties which may result from its use.

Same Sky products are not authorized or warranted for use as critical components in equipment that requires an extremely high level of reliability. A critical component is any component of a life support device or system whose failure to perform can be reasonably expected to cause the failure of the life support device or system, or to affect its safety or effectiveness.

[sameskydevices.com](https://www.sameskydevices.com)