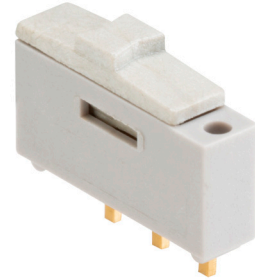

MODEL: MSS-102545-14A-V-SMT | **DESCRIPTION:** MINI SLIDE SWITCH

FEATURES

- gray raised actuator
- gray body
- vertical surface mount

SPECIFICATIONS

| parameter | conditions/description | min | typ | max | units |
|-----------------------|---|--------|-----------------|------------|------------------|
| rated voltage | | | | 12 24 | Vdc Vdc |
| rated current | at 12 Vdc at 24 Vdc | 1 1 | | 500 300 | mA mA |
| withstanding voltage | for 1 minute | | 500 | | Vac |
| contact resistance | | | | 30 | mΩ |
| insulation resistance | at 500 Vdc | 10,000 | | | MΩ |
| operating force | | 100 | 250 | 400 | gf |
| actuator travel | | | 1.6 | | mm |
| operating temperature | | -40 | | 85 | °C |
| storage temperature | | -40 | | 85 | °C |
| life | with load without load | | 2,000 10,000 | | cycles cycles |
| flammability rating | UL94V-0 | | | | |
| RoHS | yes | | | | |
| packaging | bulk, 200 pcs per bag tape and reel, 1500 pcs per reel | | | | |

PART NUMBER KEY

MSS - 102545 - 14A - V - SMT - XX

Base Number

Packaging:
"blank" = bag
TR = tape and reel

MECHANICAL DRAWING

units: mm
 tolerance: ± 0.3 mm
 unless otherwise noted

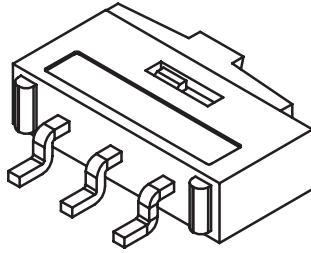

| ITEM | DESCRIPTION | MATERIAL | PLATING/COLOR |
|------|-------------|----------------|---------------|
| 1 | actuator | PA66 (UL94V-0) | gray |
| 2 | housing | PA66 (UL94V-0) | gray |
| 3 | terminals | nickel | gold |

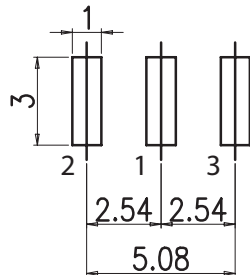
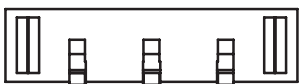
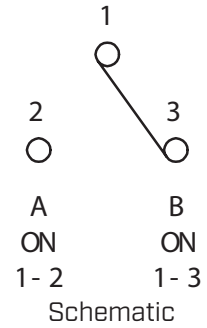
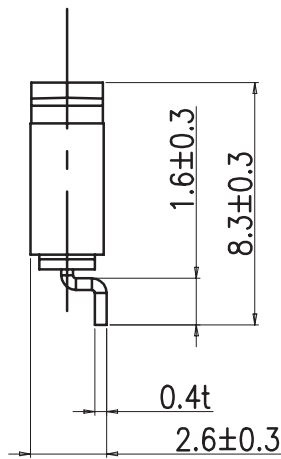
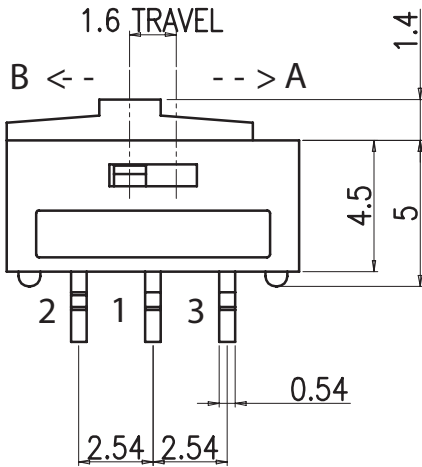
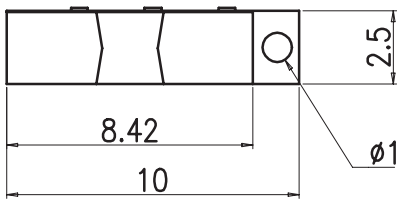

Recommended PCB Layout
 Top View

SOLDERABILITY

| parameter | conditions/description | min | typ | max | units |
|------------------|------------------------|-----|-----|-----|-------|
| reflow soldering | see graph below | | | 260 | °C |

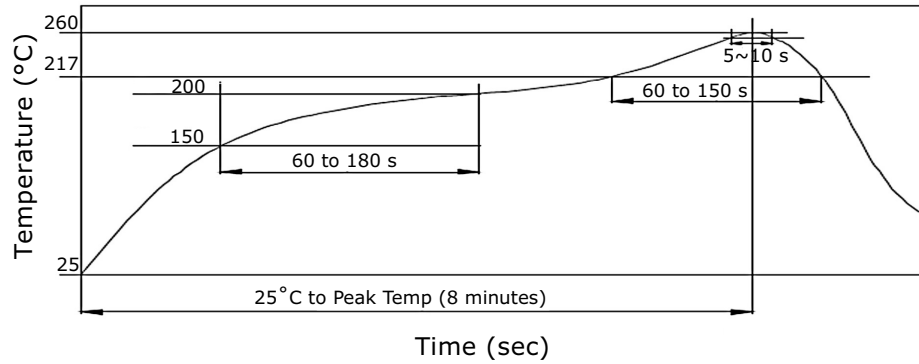

PACKAGING (TAPE & REEL)

units: mm

Reel Size: Ø330 mm
Reel QTY: 1,500 pcs per reel

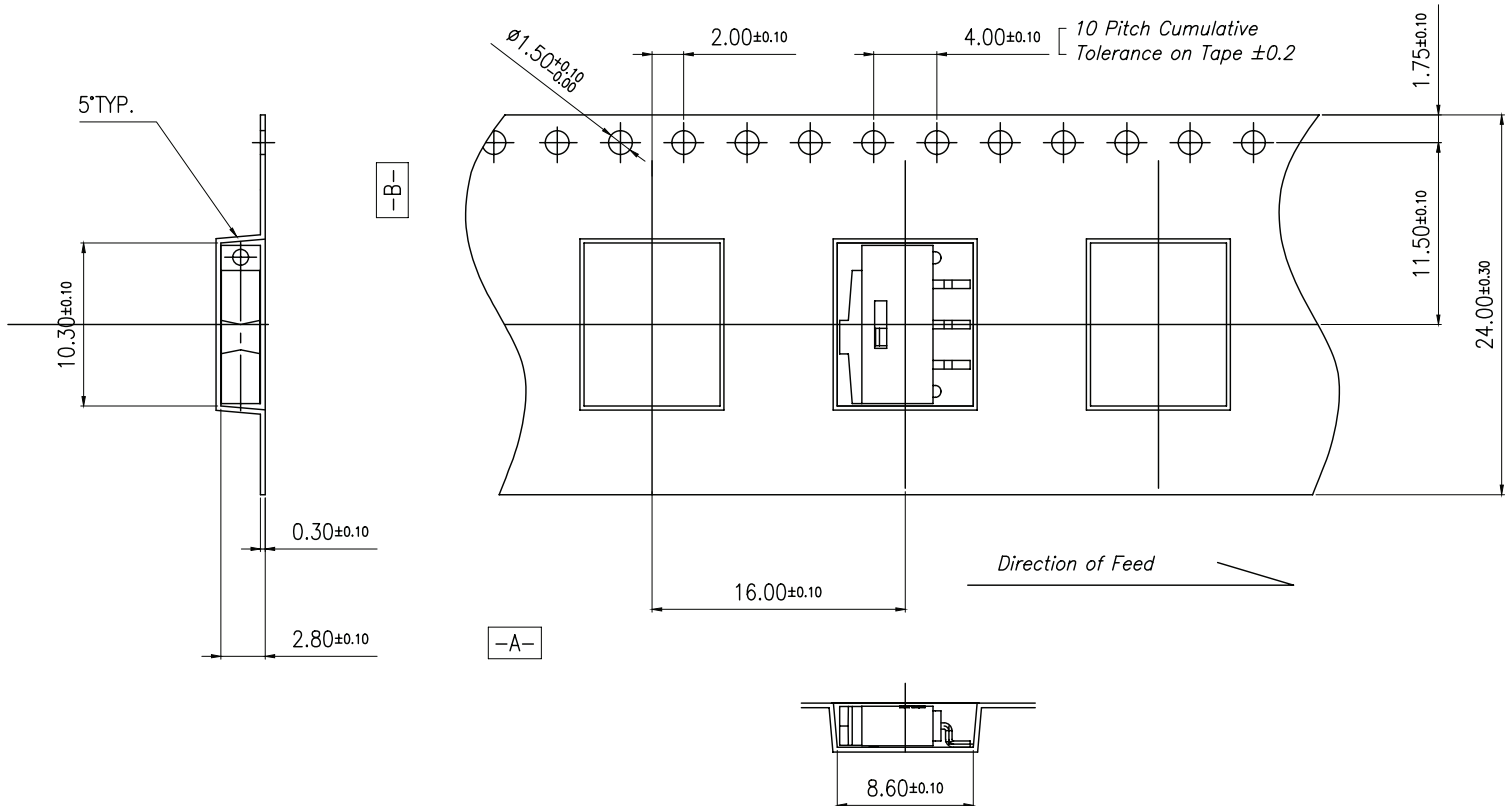

REVISION HISTORY

| rev. | description | date |
|------|--------------------------------------|------------|
| 1.0 | initial release | 02/19/2021 |
| 1.01 | logo, datasheet style update | 08/05/2022 |
| 1.02 | updated datasheet | 07/28/2023 |
| 1.03 | added tape and reel packaging option | 10/31/2023 |
| 1.04 | CUI Devices rebranded to Same Sky | 09/12/2024 |

The revision history provided is for informational purposes only and is believed to be accurate.



Same Sky offers a one (1) year limited warranty. Complete warranty information is listed on our website.

Same Sky reserves the right to make changes to the product at any time without notice. Information provided by Same Sky is believed to be accurate and reliable. However, no responsibility is assumed by Same Sky for its use, nor for any infringements of patents or other rights of third parties which may result from its use.

Same Sky products are not authorized or warranted for use as critical components in equipment that requires an extremely high level of reliability. A critical component is any component of a life support device or system whose failure to perform can be reasonably expected to cause the failure of the life support device or system, or to affect its safety or effectiveness.

[sameskydevices.com](https://www.sameskydevices.com)