

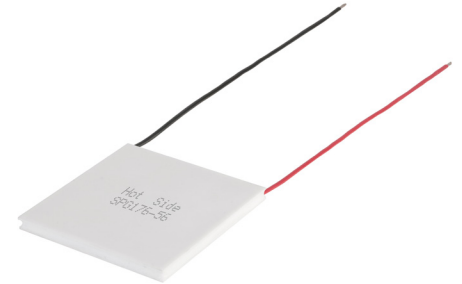

MODEL: SPG176-56 | DESCRIPTION: THERMOELECTRIC GENERATOR

FEATURES

- TEG module
- 17.6 W output
- up to 300°C continuous maximum hot side temp
- silicone sealed
- graphite pad option available



SPECIFICATIONS

| parameter | conditions/description | min | typ | max | units |
|-----------------------------|---|-----|------|-----|-------------------|
| open circuit voltage | at Th = 300°C, Tc = 30°C | | 17.7 | | V |
| matched load resistance | at Th = 300°C, Tc = 30°C | | 4.4 | | Ω |
| matched load output voltage | at Th = 300°C, Tc = 30°C | | 8.8 | | V |
| matched load output current | at Th = 300°C, Tc = 30°C | | 2.0 | | A |
| matched load output power | at Th = 300°C, Tc = 30°C | | 17.6 | | W |
| heat flow across module | | | 301 | | W |
| heat flow density | | | 9.6 | | W/cm ² |
| ac resistance | at 27 °C, 1000 Hz | 2.2 | | 3.0 | Ω |
| solder melting temperature | cold side: SnAgSn solder hot side: no solder, aluminum bonding | 217 | | | °C |
| hot side plate | | -60 | | 300 | °C |
| cold side plate | | -60 | | 180 | °C |
| assembly compression | | | | 1.4 | MPa |
| mounting torque per screw | screw diameter / # of screws: 5 mm / 2 | | 0.3 | | kg-m |
| RoHS | yes | | | | |

Note: 1. Product available with graphite pad on hot/cold, please inquire with Same Sky sales.

MECHANICAL DRAWING

units: mm

| | MATERIAL | PLATING |
|---------------|---|---------|
| ceramic plate | 96% Al_2O_3 | |
| wire leads | AF250 22 AWG | tin |
| sealer | BG SIDUN 3.0 (between cold and hot side plates) | |
| marking | P/N & "HOT SIDE" printed on hot side surface | |

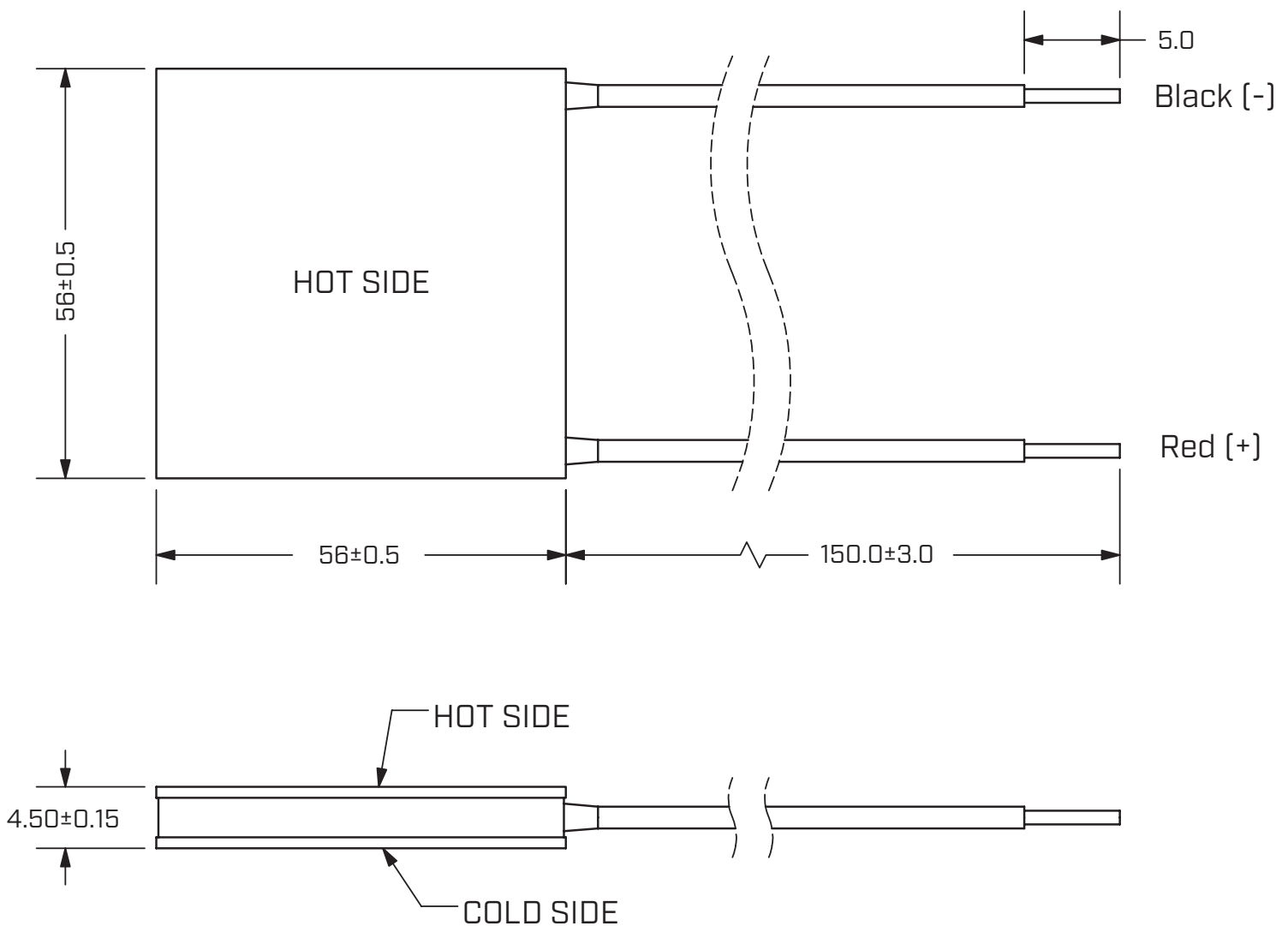

PERFORMANCE CURVES

Open Circuit Voltage Vs. Th

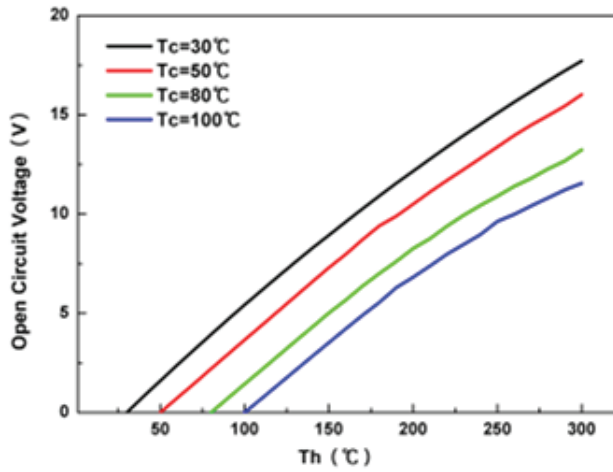

Matched Load Resistance Vs. Th

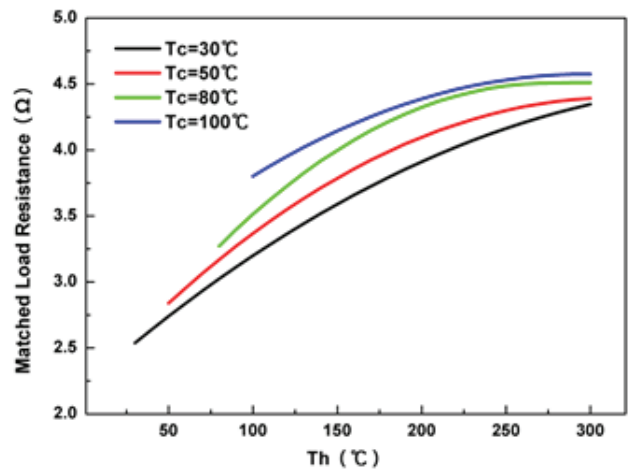

Matched Load Voltage Vs. Th

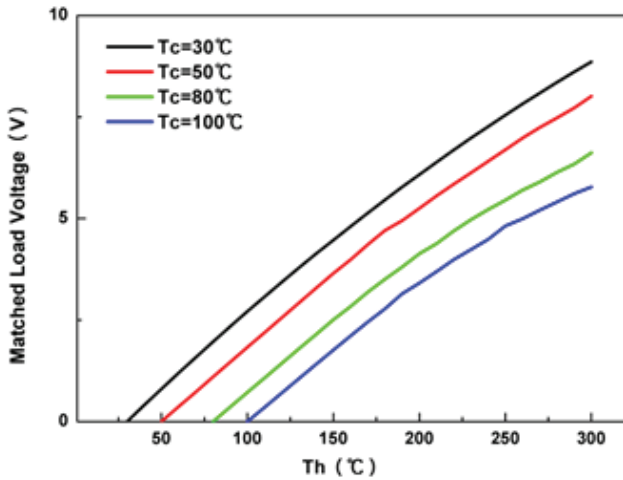

Matched Load Current Vs. Th

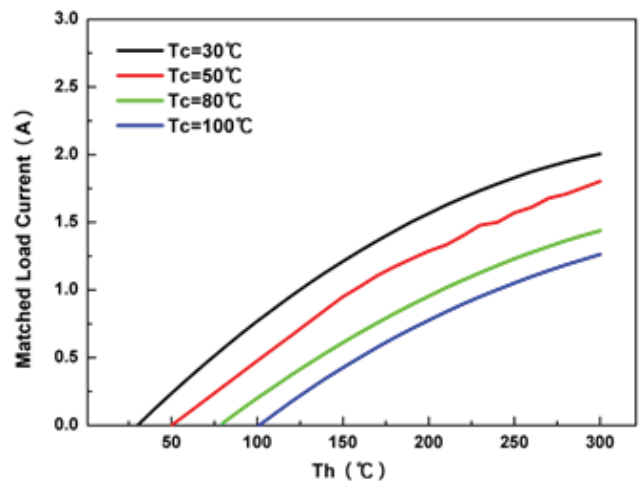

Matched Load Output Power Vs. Th

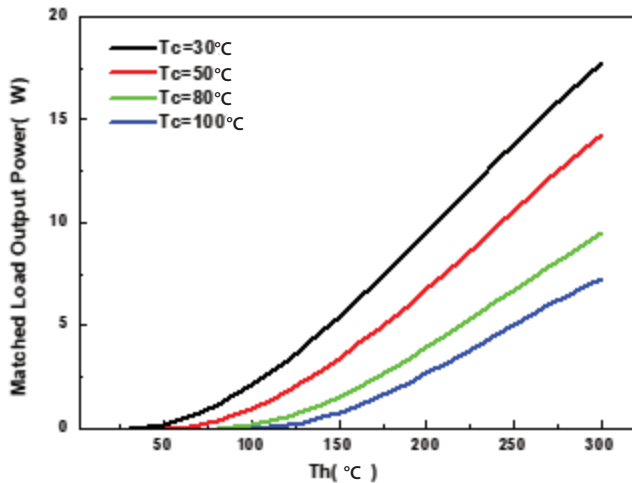

Output Voltage/Power Vs. Output Current (Th=300°C, Tc= 30°C)

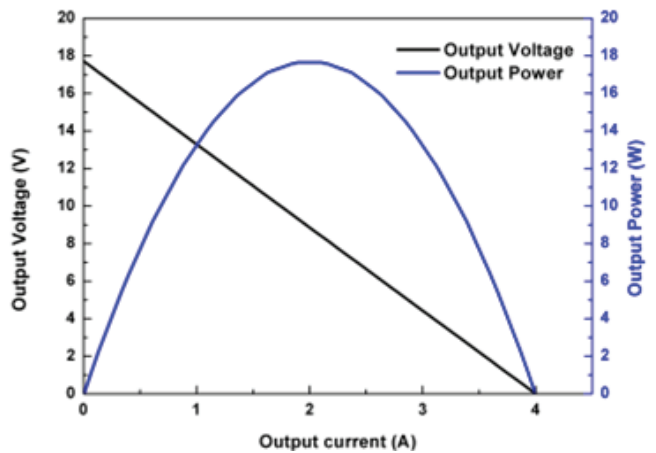

REVISION HISTORY

| rev. | description | date |
|------|-----------------|------------|
| 1.0 | initial release | 11/13/2024 |

The revision history provided is for informational purposes only and is believed to be accurate.



Same Sky offers a one (1) year limited warranty. Complete warranty information is listed on our website.

Same Sky reserves the right to make changes to the product at any time without notice. Information provided by Same Sky is believed to be accurate and reliable. However, no responsibility is assumed by Same Sky for its use, nor for any infringements of patents or other rights of third parties which may result from its use.

Same Sky products are not authorized or warranted for use as critical components in equipment that requires an extremely high level of reliability. A critical component is any component of a life support device or system whose failure to perform can be reasonably expected to cause the failure of the life support device or system, or to affect its safety or effectiveness.

[sameskydevices.com](https://www.sameskydevices.com)