



MODEL: CUSA-T80-12-2600-TH | **DESCRIPTION:** ULTRASONIC SENSOR

FEATURES

- aluminium can
- open type
- transmitter
- SPL 115 dB
- detectable range 12 meters



SPECIFICATIONS

parameter	conditions/description	min	typ	max	units
type	transmitter				
operating voltage	at 25 kHz			180	Vp-p
frequency		24	25	26	kHz
sound pressure level	at 10 V, 30 cm, sine wave	115			dB
directivity			80		degree
capacitance	at 1 kHz	2,080	2,600	3,120	pF
detectable range		0.2		12	m
dimensions	Ø16.0 x 12.0				mm
material	aluminum				
terminal	pins (iron with tin plating)				
weight			2.31		g
operating temperature		-30		85	°C
RoHS	yes				

SOLDERABILITY

parameter	conditions/description	min	typ	max	units
wave soldering				250	°C

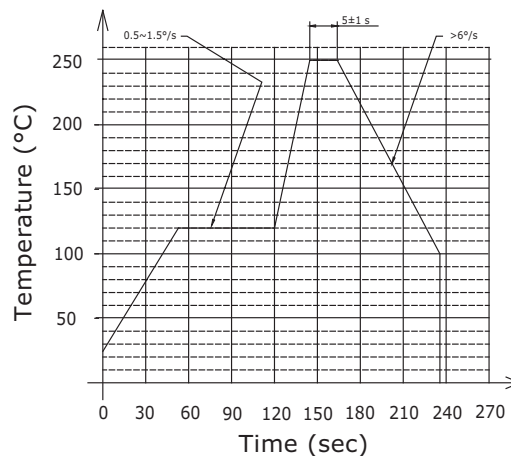

MECHANICAL DRAWING

units: mm

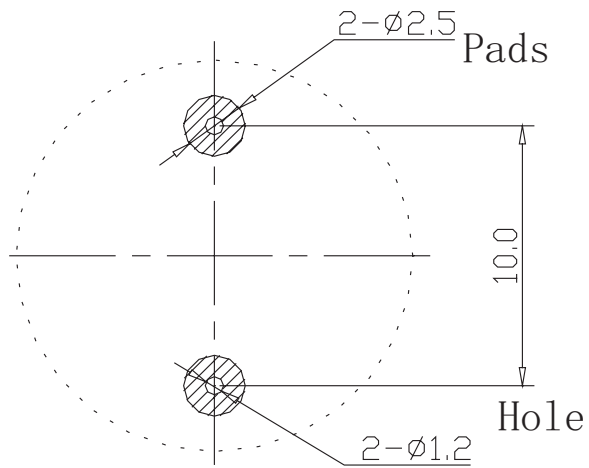
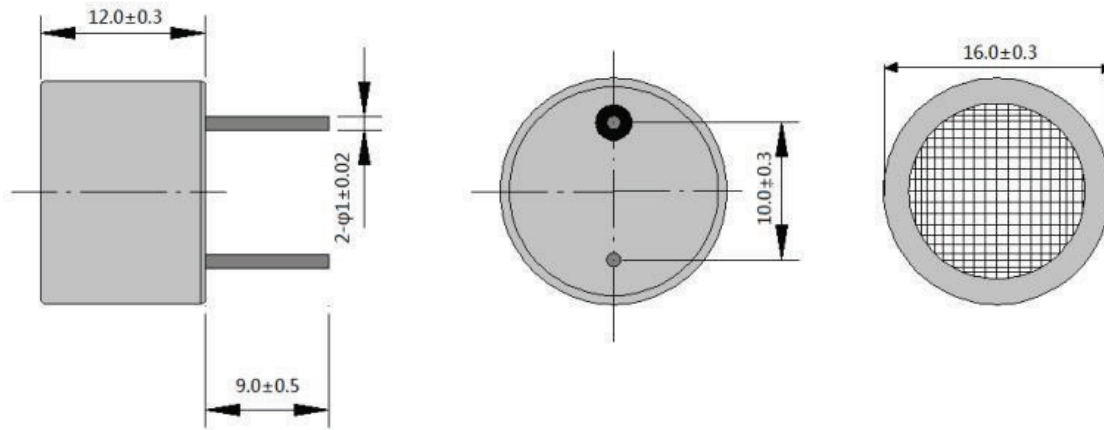

Recommended PCB Layout
Top View

BEAM PATTERNS

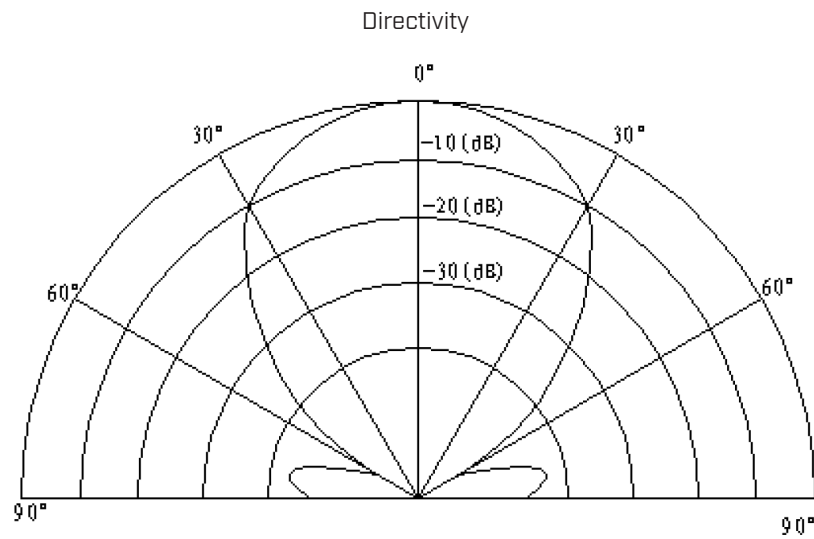
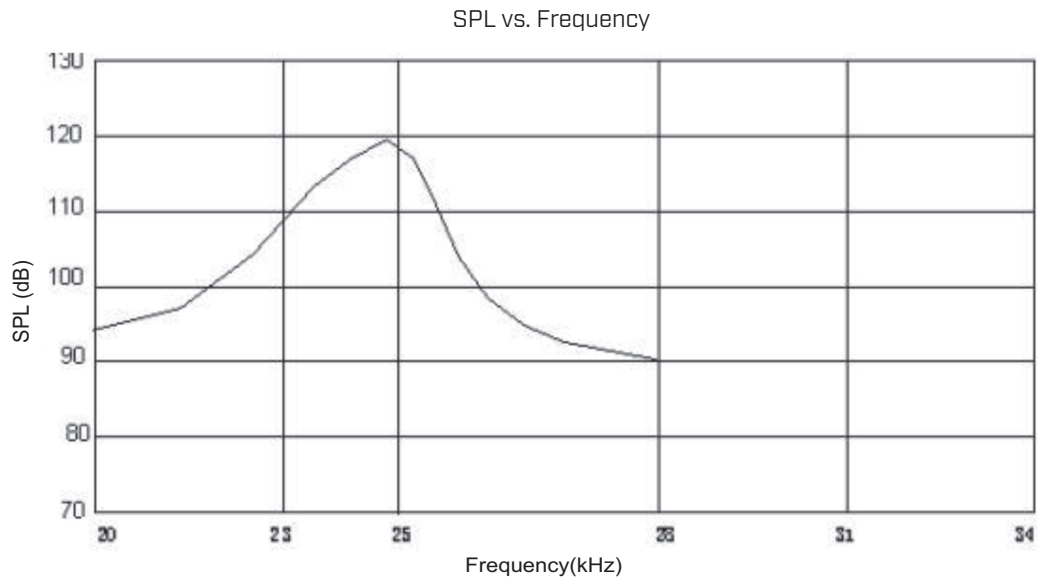

PACKAGING

units: mm

Tray Size: 240 x 160 x 30 mm
Tray QTY: 50 pcs per tray
Carton Size: 480 x 280 x 320 mm
Carton QTY: 2,000 pcs per carton

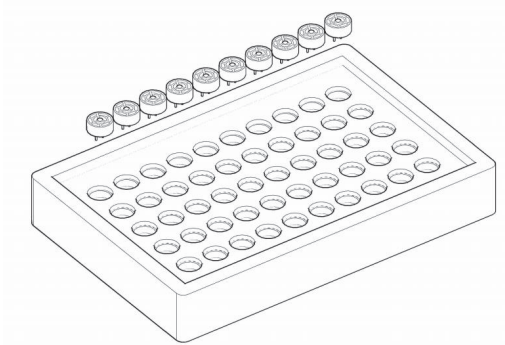

50PCS/BOX
BOX SIZE:24*16*3CM

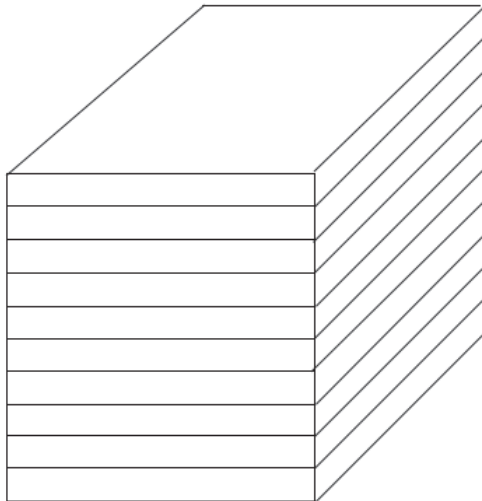

10BOXES/STACK, TOTAL 500PCS
STACK SIZE:24*16*24CM

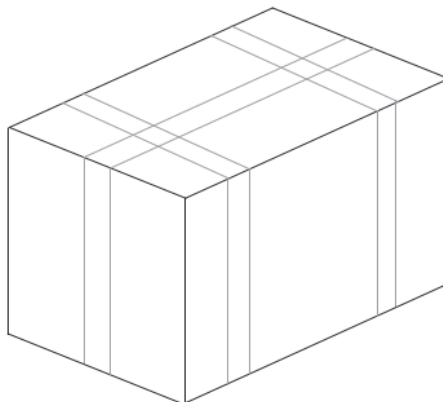

2000PCS/CARTON
CARTON SIZE:48*28*32CM

REVISION HISTORY

rev.	description	date
1.0	initial release	12/02/2020
1.01	logo, datasheet style update	08/05/2022
1.02	CUI Devices rebranded to Same Sky	09/12/2024

The revision history provided is for informational purposes only and is believed to be accurate.



Same Sky offers a one (1) year limited warranty. Complete warranty information is listed on our website.

Same Sky reserves the right to make changes to the product at any time without notice. Information provided by Same Sky is believed to be accurate and reliable. However, no responsibility is assumed by Same Sky for its use, nor for any infringements of patents or other rights of third parties which may result from its use.

Same Sky products are not authorized or warranted for use as critical components in equipment that requires an extremely high level of reliability. A critical component is any component of a life support device or system whose failure to perform can be reasonably expected to cause the failure of the life support device or system, or to affect its safety or effectiveness.

[sameskydevices.com](https://www.sameskydevices.com)