

**MODEL:** CPG-10-SMT-B | **DESCRIPTION:** POGO PIN**FEATURES**

- pogo pin
- surface mount
- gold plated

**SPECIFICATIONS**

parameter	conditions/description	min	typ	max	units
rated voltage				12	Vdc
rated current				1	A
contact resistance	at working height			100	mΩ
force	at minimum compression	40	60	80	gf
	at working height	50	70	90	gf
	at maximum compression	60	80	100	gf
mid stroke			0.45		mm
full stroke			0.55		mm
working height			1.85		mm
life		10,000			cycles
operating temperature		-40		85	°C
RoHS	yes				

MECHANICAL DRAWING

units: mm
 tolerance:
 X.X: ±0.15 mm
 X.XX: ±0.10 mm
 PCB: ±0.05 mm
 unless otherwise noted

DESCRIPTION	MATERIAL	PLATING/COLOR
barrel	brass	0.1 µm min gold over 1.4 µm min nickel
plunger	brass	0.25 µm min gold over 1.4 µm min nickel
spring	stainless steel wire	

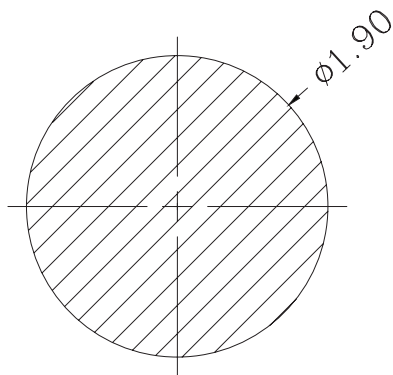
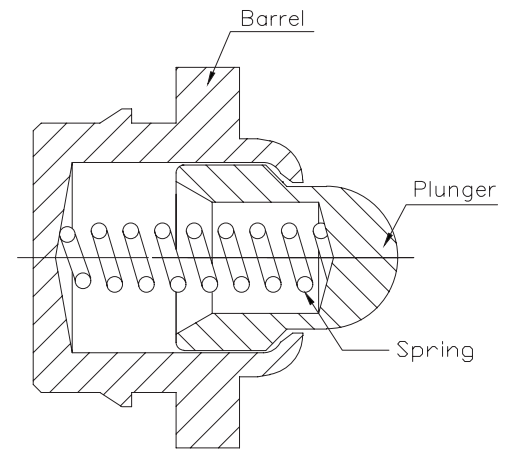
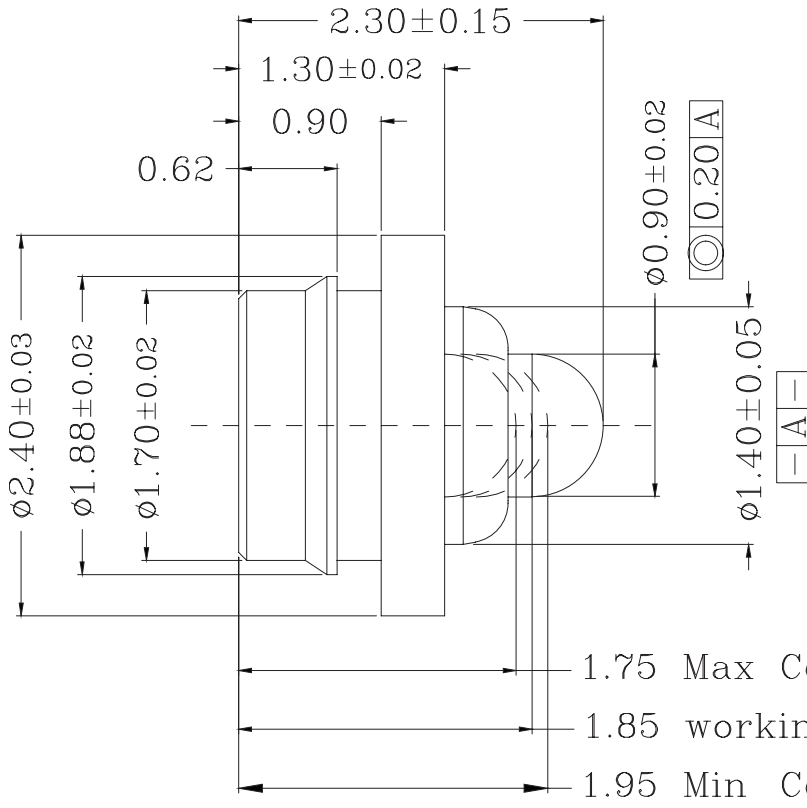

Recommended PCB Layout
 Top View

REVISION HISTORY

rev.	description	date
1.0	initial release	11/04/2024

The revision history provided is for informational purposes only and is believed to be accurate.



Same Sky offers a one (1) year limited warranty. Complete warranty information is listed on our website.

Same Sky reserves the right to make changes to the product at any time without notice. Information provided by Same Sky is believed to be accurate and reliable. However, no responsibility is assumed by Same Sky for its use, nor for any infringements of patents or other rights of third parties which may result from its use.

Same Sky products are not authorized or warranted for use as critical components in equipment that requires an extremely high level of reliability. A critical component is any component of a life support device or system whose failure to perform can be reasonably expected to cause the failure of the life support device or system, or to affect its safety or effectiveness.

[sameskydevices.com](https://www.sameskydevices.com)