

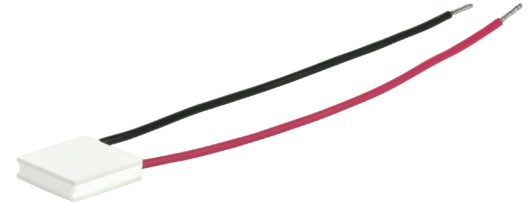

SERIES: CP70 | **DESCRIPTION:** PELTIER MODULE

FEATURES

- arcTEC™ structure on select models
- solid state device
- precise temperature control
- quiet operation



MODEL

MODEL	input voltage ¹	input current ²	internal resistance ³	output Qmax ⁴		output ΔTmax ⁵	
	max [Vdc]	max [A]	typ [Ω±10%]	T _n =27°C [W]	T _n =50°C [W]	T _h =27°C [°C]	T _h =50°C [°C]
CP70137	2.1	7.0	0.24	7.5	8.3	68	75
CP70237	3.8	7.0	0.42	13.6	15.1	68	75
CP70301537	4.2	7.0	0.48	15.4	17.1	68	75
CP70337 ⁶	8.6	7.0	1.0	31.0	34.6	70	77
CP70437 ⁶	15.4	7.0	1.75	55.0	60.5	70	77

- Notes:
1. Maximum voltage at ΔT max and T_n=27°C
 2. Maximum current to achieve ΔT max
 3. Measured by AC 4-terminal method at 25°C
 4. Maximum heat absorbed at cold side occurs at I_{max}, V_{max}, and ΔT=0°C
 5. Maximum temperature difference occurs at I_{max}, V_{max}, and Q=0W (ΔT max measured in a vacuum at 1.3 Pa)
 6. Designed with arcTEC™ structure

SPECIFICATIONS

parameter	conditions/description	min	typ	max	units
solder melting temperature	connection between thermoelectric pairs	235			°C
assembly compression				1	MPa
hot side plate				80	°C
RoHS	yes				

MECHANICAL DRAWING

units: mm

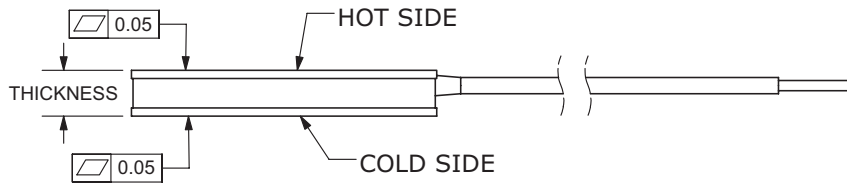

	MATERIAL	PLATING
ceramic plate	96% AL ₂ O ₃	
wire leads	20 AWG	tin
sealer	silicon rubber 703 RTV (between cold and hot side plates)	
joint cover	silicon rubber 703 RTV	
marking	P/N & S/N printed on cold side surface	

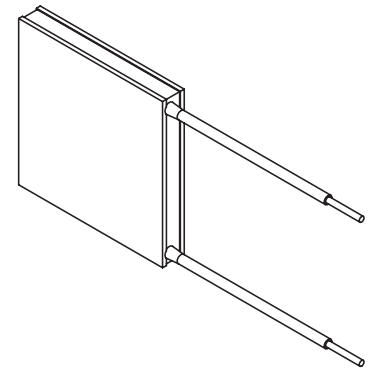
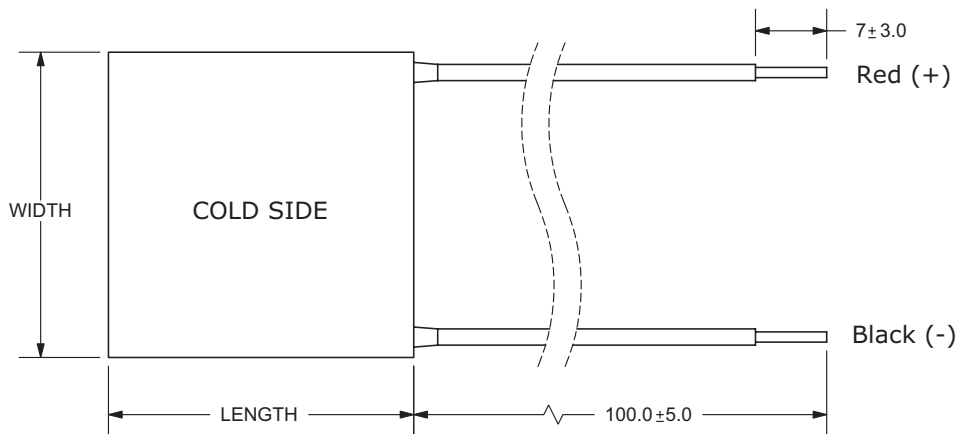

MODEL NO.	LENGTH (mm)	WIDTH (mm)	THICKNESS (mm)
CP70137	15 ± 0.3	15 ± 0.3	3.7 ± 0.1
CP70237	20 ± 0.3	20 ± 0.3	3.7 ± 0.1
CP70301537	30 ± 0.3	15 ± 0.3	3.7 ± 0.1
CP70337 ¹	30 ± 0.3	30 ± 0.3	3.7 ± 0.1
CP70437 ¹	40 ± 0.3	40 ± 0.3	3.7 ± 0.1

Notes: 1. Wire lead strip length on models CP70337 & CP70437 is 10 ± 3.0 mm.

CP70137 PERFORMANCE (Th=27°C)

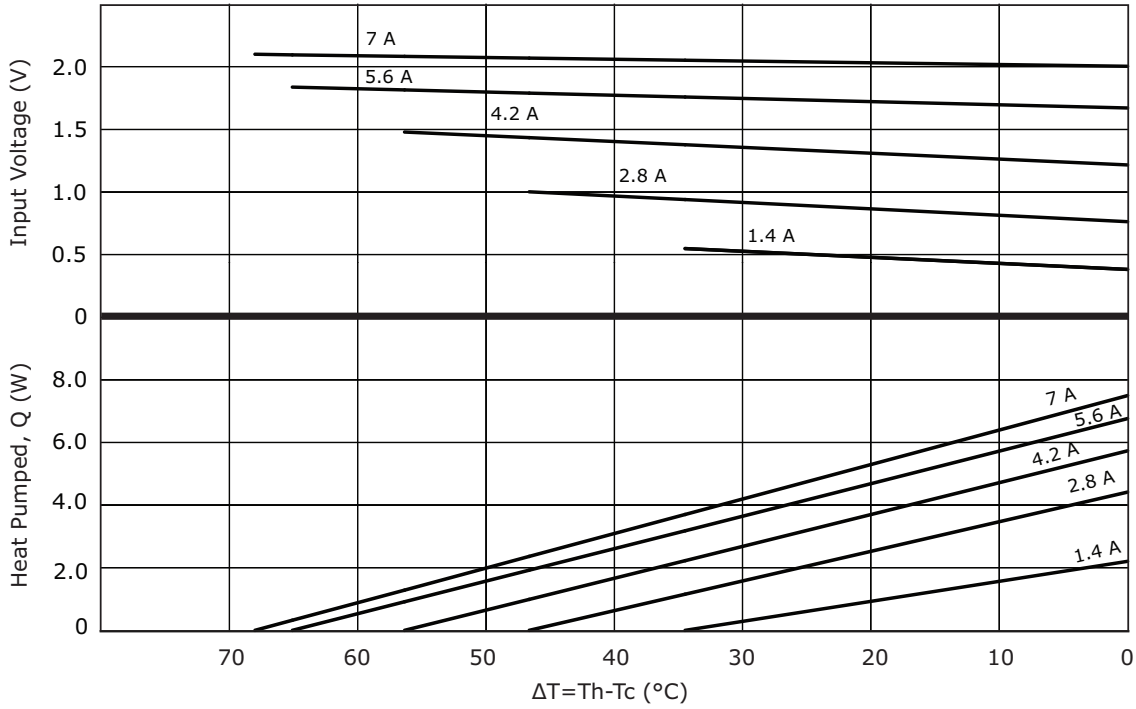

CP70137 PERFORMANCE (Th=50°C)

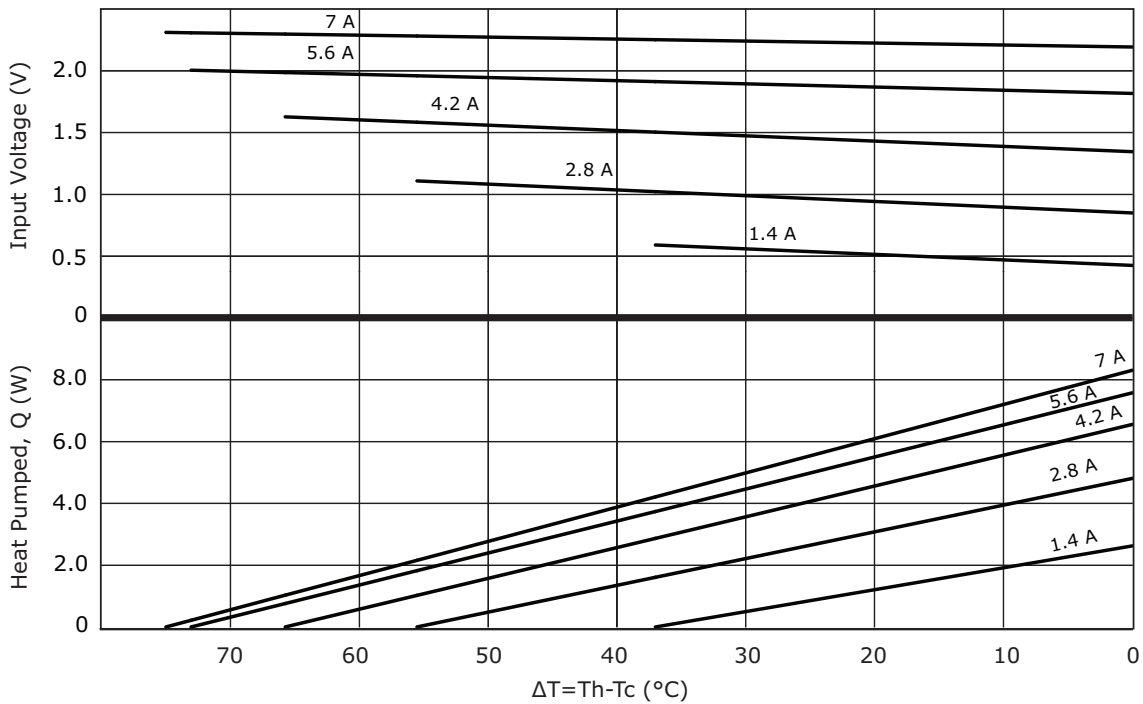

CP70237 PERFORMANCE (Th=27°C)

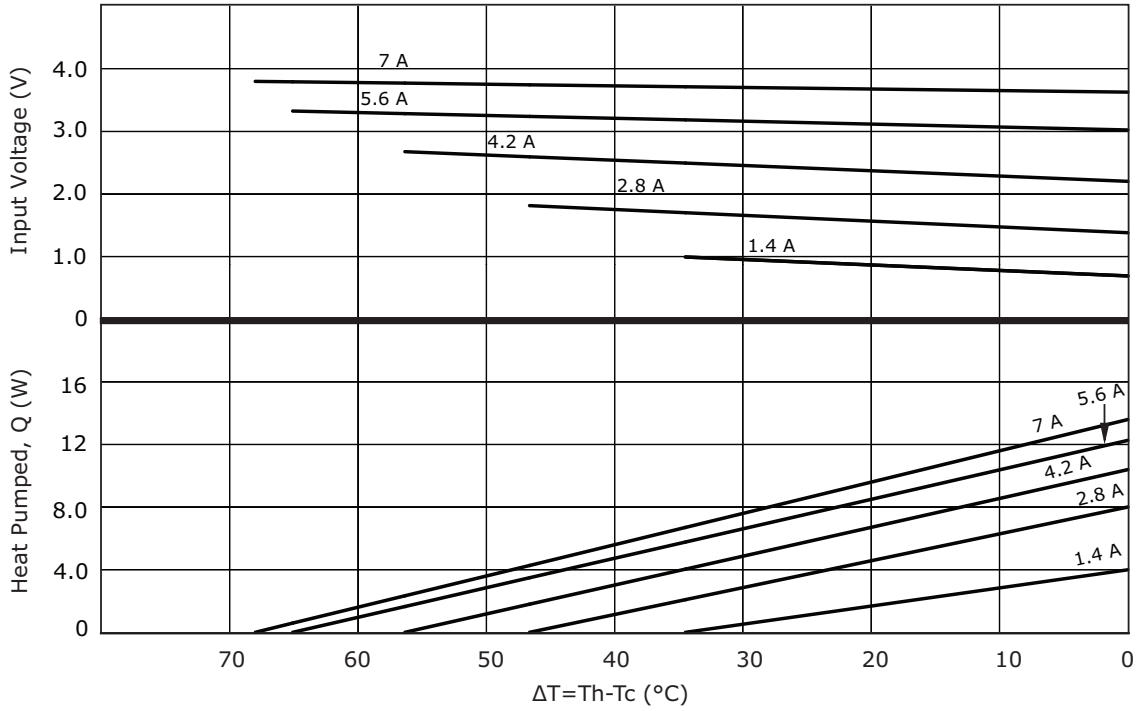

CP70237 PERFORMANCE (Th=50°C)

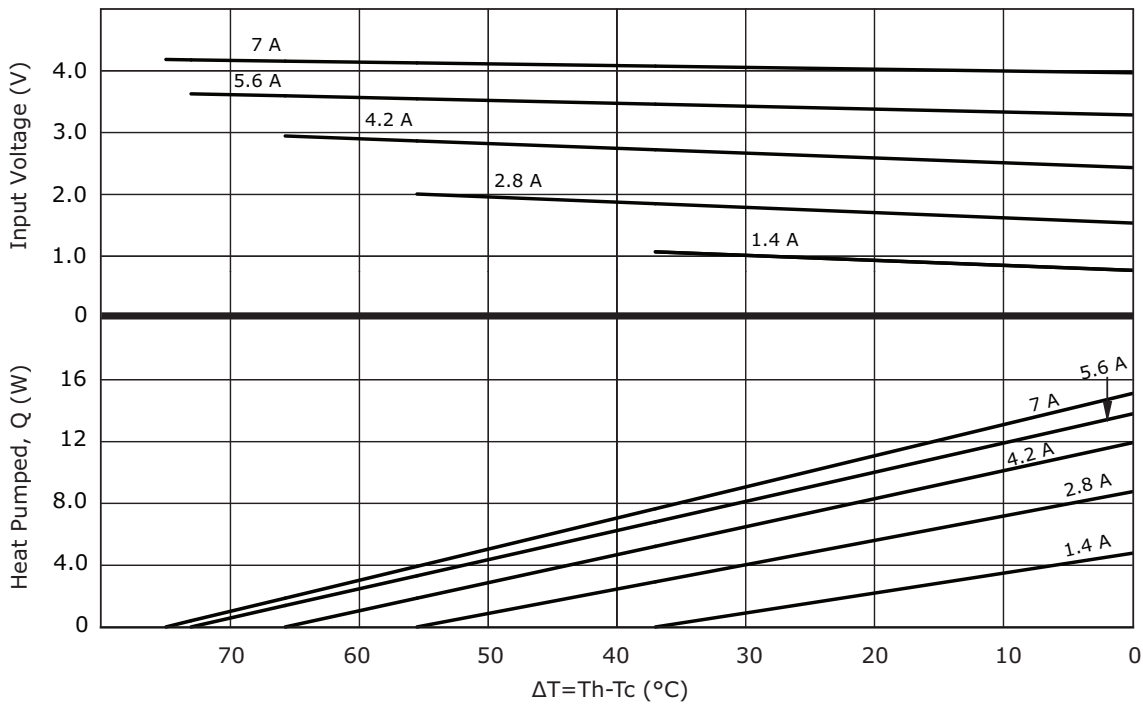

CP70301537 PERFORMANCE (Th=27°C)

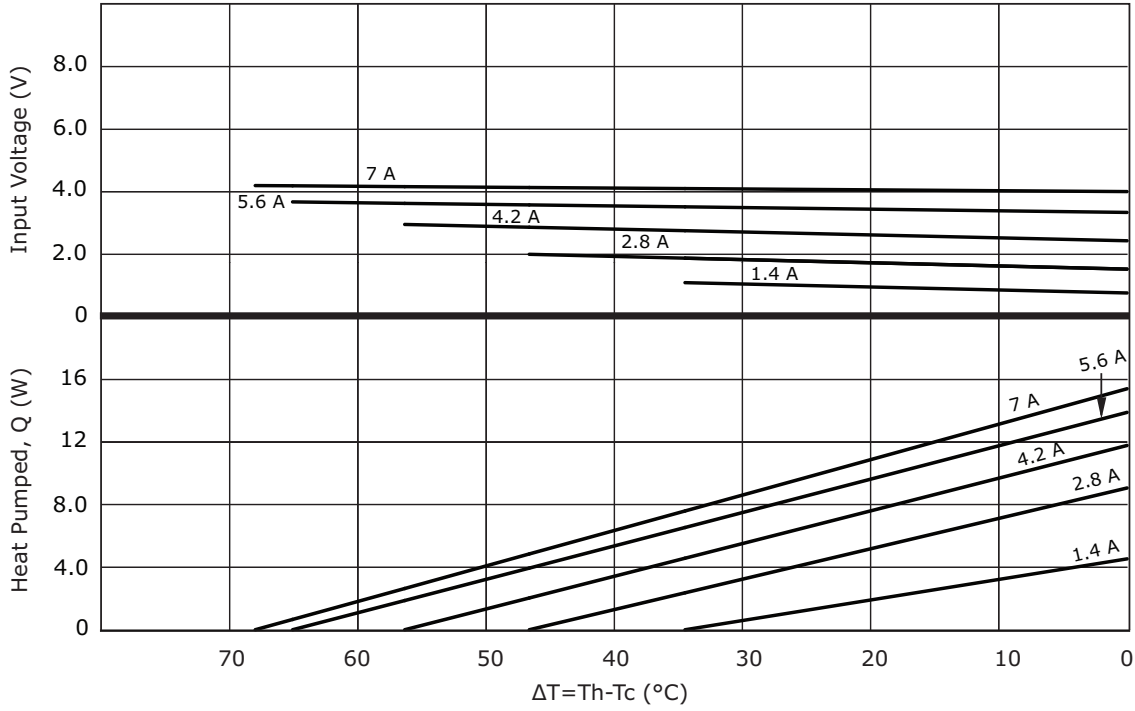

CP70301537 PERFORMANCE (Th=50°C)

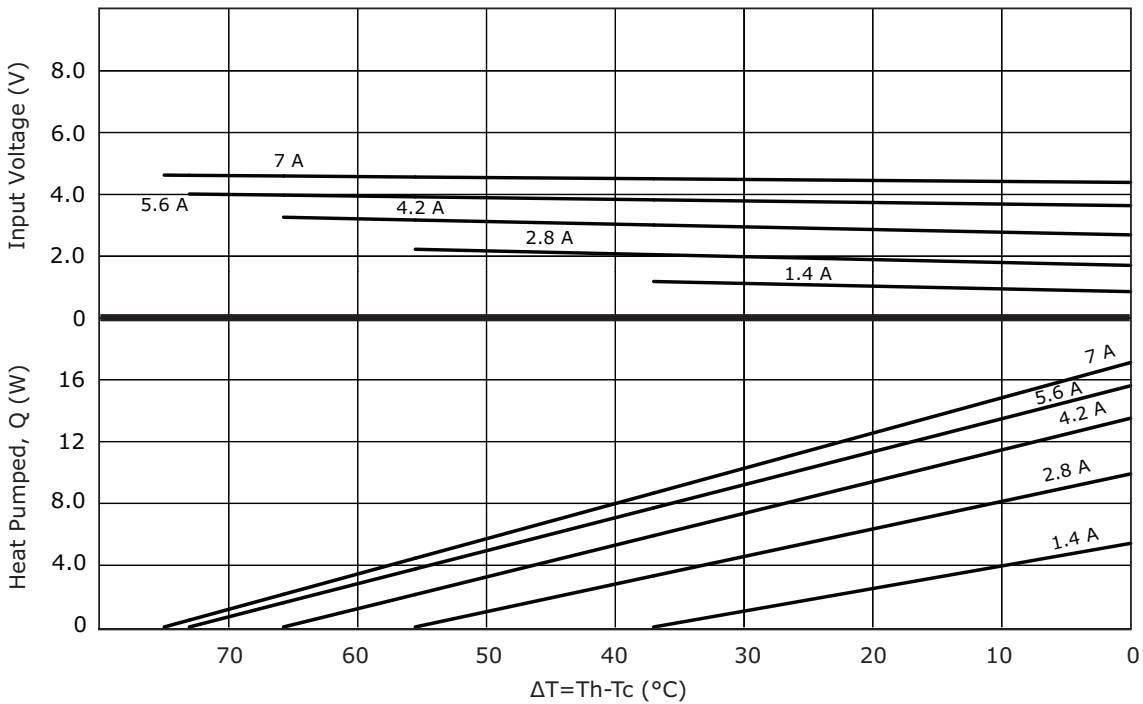

CP70337 PERFORMANCE (Th=27°C)

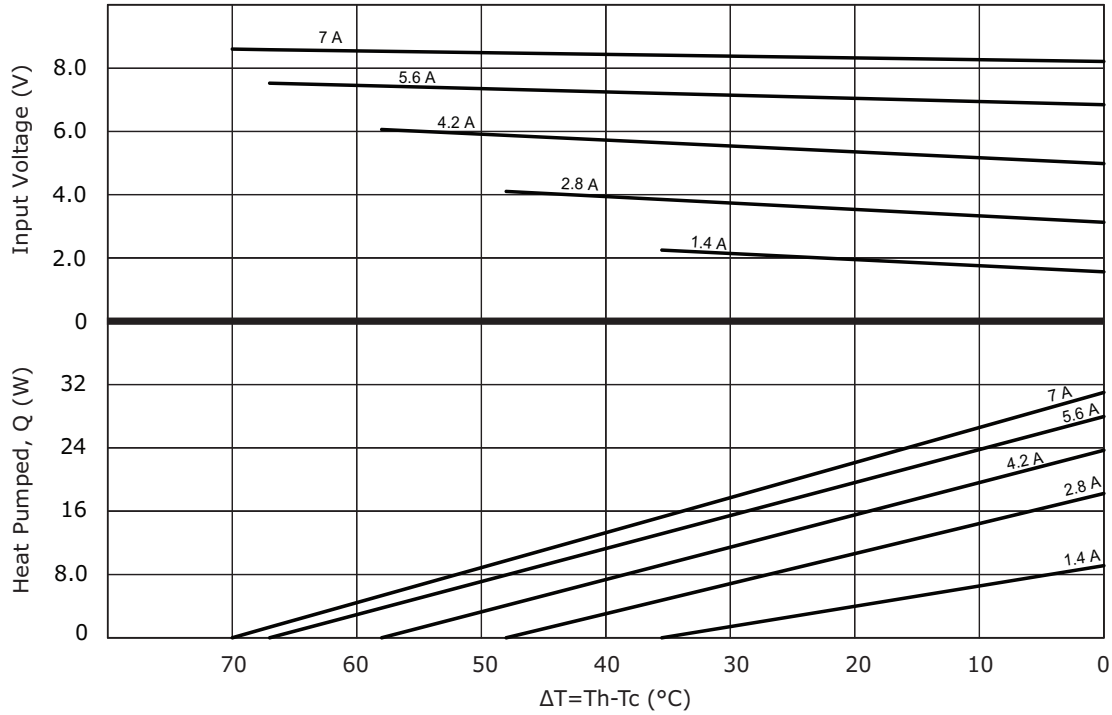

CP70337 PERFORMANCE (Th=50°C)

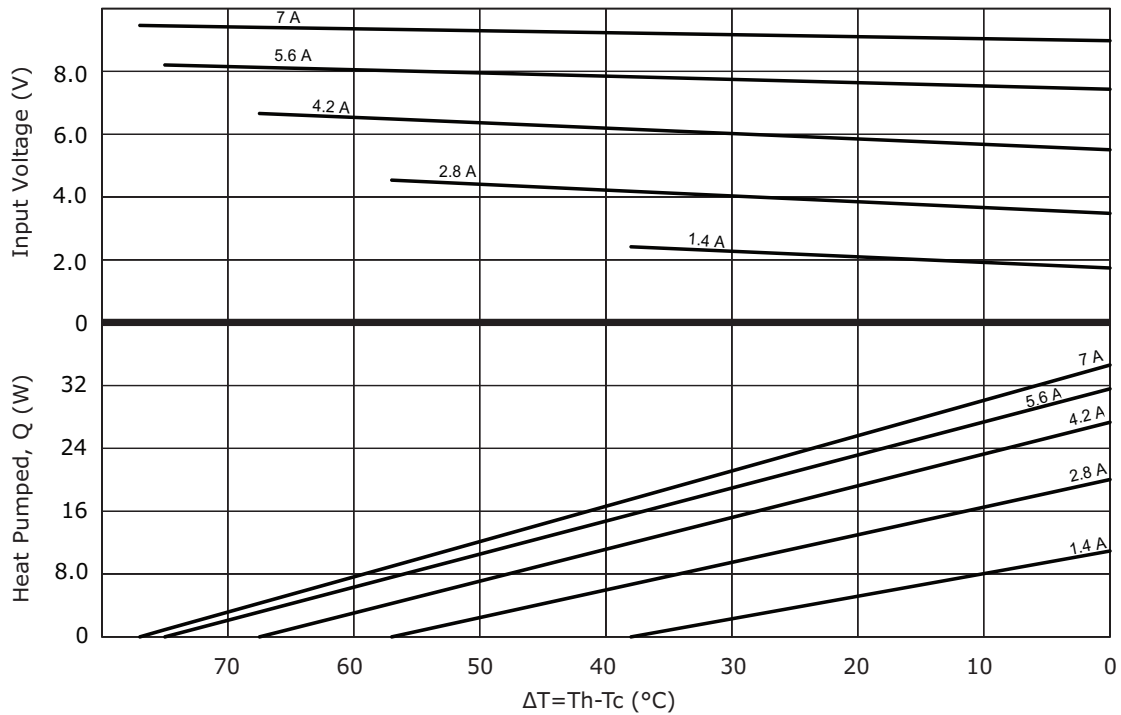

CP70437 PERFORMANCE (Th=27°C)

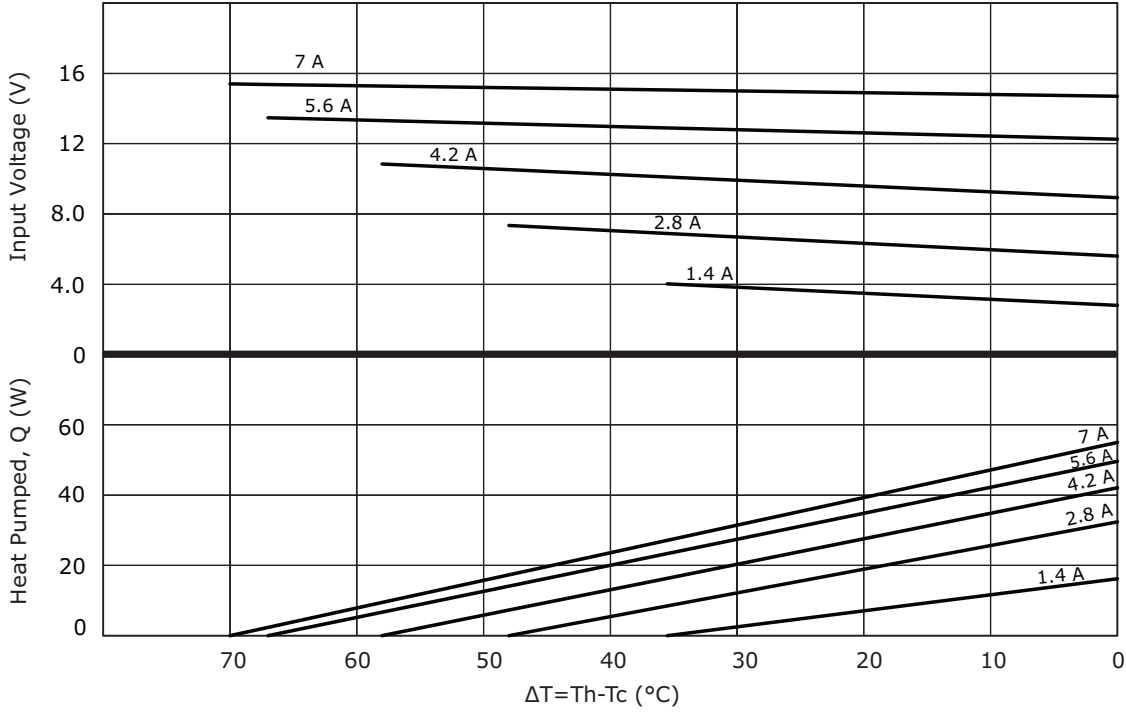

CP70437 PERFORMANCE (Th=50°C)

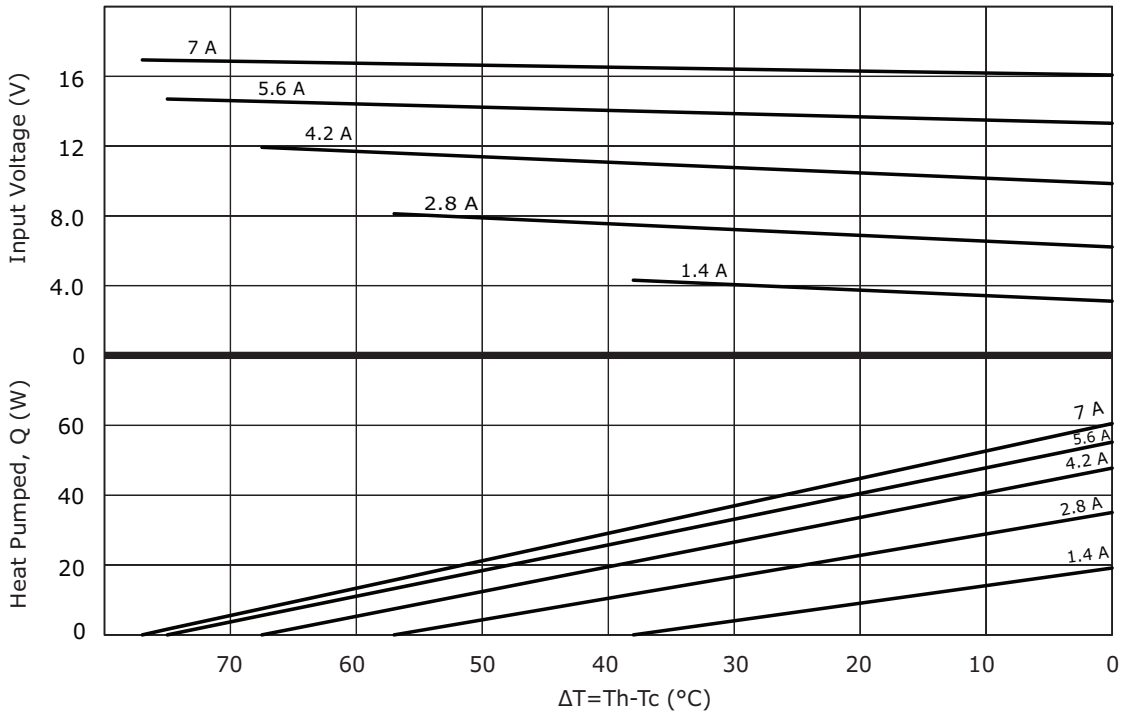

REVISION HISTORY

rev.	description	date
1.0	initial release	09/08/2016
1.01	changed models CP70337 & CP70437 to arcTEC™ structure	12/01/2017
1.02	changed thickness of CP70137, CP70237, CP70301537 models	09/19/2018
1.03	brand update	10/30/2019
1.04	logo, datasheet style update	08/05/2022
1.05	CUI Devices rebranded to Same Sky	09/12/2024

The revision history provided is for informational purposes only and is believed to be accurate.



Same Sky offers a one (1) year limited warranty. Complete warranty information is listed on our website.

Same Sky reserves the right to make changes to the product at any time without notice. Information provided by Same Sky is believed to be accurate and reliable. However, no responsibility is assumed by Same Sky for its use, nor for any infringements of patents or other rights of third parties which may result from its use.

Same Sky products are not authorized or warranted for use as critical components in equipment that requires an extremely high level of reliability. A critical component is any component of a life support device or system whose failure to perform can be reasonably expected to cause the failure of the life support device or system, or to affect its safety or effectiveness.

[sameskydevices.com](https://www.sameskydevices.com)