



## MODEL: CMS-40208N | DESCRIPTION: SPEAKER

### FEATURES

- 650 Hz resonant frequency
- 98 dB SPL
- Nd-Fe-B magnet



### SPECIFICATIONS

parameter	conditions/description	min	typ	max	units
input power	maximum power: IEC-60268-5, filter 60s on/120s off, 10 cycles at room temp		1.0	1.5	W
impedance	at 1.0 V, 2.0 kHz	6.8	8	9.2	$\Omega$
resonant frequency (Fo)	at 1.0 V	520	650	780	Hz
frequency response	output SPL -10 dB	Fo		13,000	Hz
sound pressure level	at 1.0 W, 0.1 m ave, at 0.8, 1.0, 1.2, 1.5 kHz	95	98	101	dB
distortion	at 1.0 kHz, 1.0 W			10	%
buzz, rattle, etc.	must be normal at sine wave between Fo ~ 20,000 Hz		2.83		V
dimensions	40 x 20 x 8.4				mm
magnet	Nd-Fe-B				
material	ABS				
cone material	cloth				
terminal	solder terminals				
weight			7		g
operating temperature		-30		70	$^{\circ}\text{C}$
storage temperature		-40		85	$^{\circ}\text{C}$
RoHS	yes				

Notes: 1. All specifications measured at 5-35 $^{\circ}\text{C}$ , humidity at 45-85%, under 86-106 kPa pressure, unless otherwise noted.

### SOLDERABILITY

parameter	conditions/description	min	typ	max	units
hand soldering	for maximum 3 seconds	370	380	390	$^{\circ}\text{C}$

## MECHANICAL DRAWING

units: mm  
tolerance:  $\pm 0.5$  mm

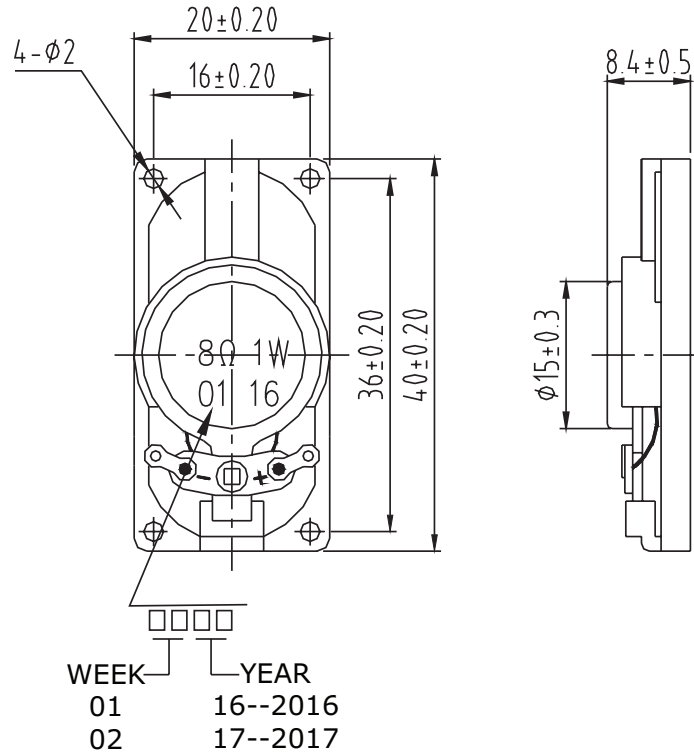

## FREQUENCY RESPONSE CURVE

Frequency Response.Magn dB re 20.00 $\mu$  PA (at 1 W / 0.1 m)

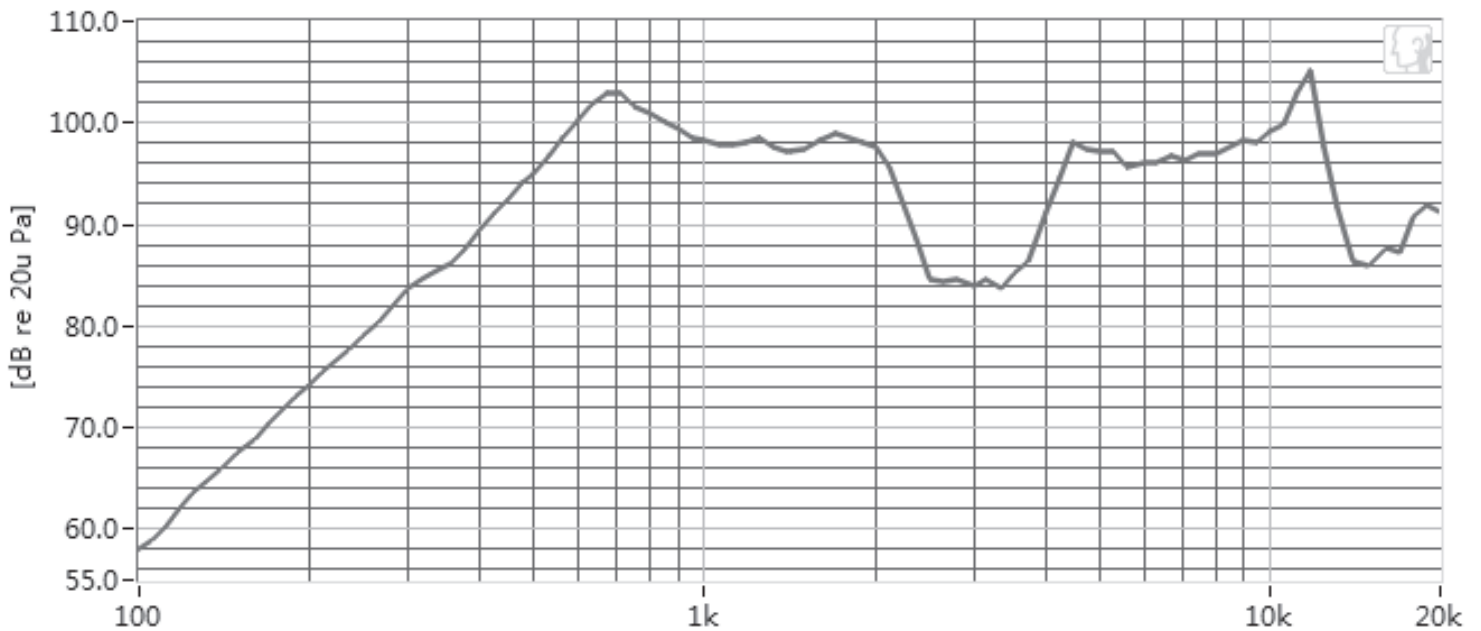

## PACKAGING

units: mm

Tray Size: 330 x 250 x 13 mm  
 Carton Size: 345 x 265 x 305 mm  
 Tray QTY: 50 pcs per tray  
 Carton QTY: 1,000 pcs per carton

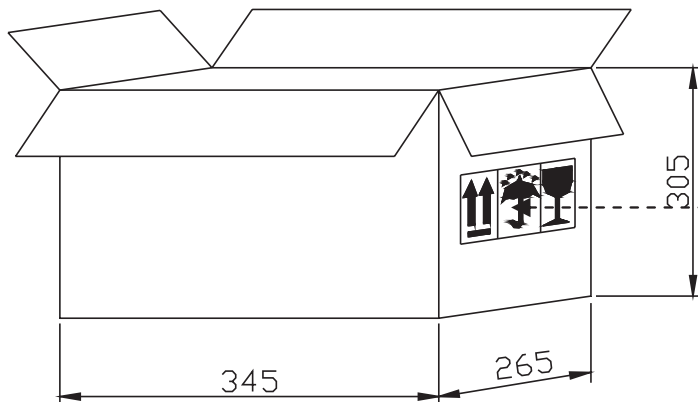
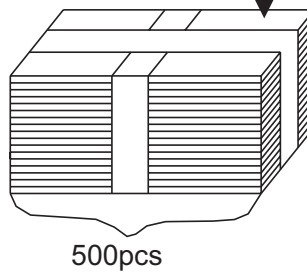
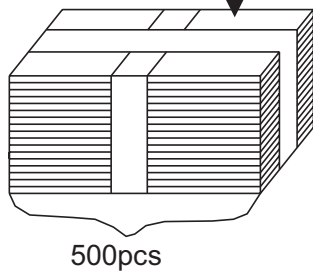
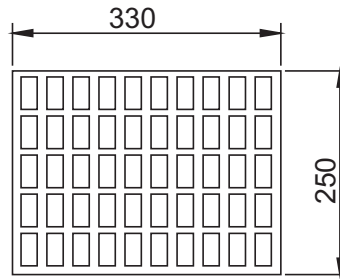

Lot No.	XXXXXXXXXX
Model No.	Inv# XXXXXXXXXXXX Part# XXXXXXXXXXXX
Quantity.	XXXX Pcs
Date:	
DD MM YY	
MADE IN CHINA	
	

\* The label stuck on inner boxes and the outer of carton.

## REVISION HISTORY

rev.	description	date
1.0	initial release	06/23/2016
1.01	brand update	01/22/2020
1.02	logo, datasheet style update	08/05/2022
1.03	CUI Devices rebranded to Same Sky	09/11/2024

The revision history provided is for informational purposes only and is believed to be accurate.



Same Sky offers a one (1) year limited warranty. Complete warranty information is listed on our website.

Same Sky reserves the right to make changes to the product at any time without notice. Information provided by Same Sky is believed to be accurate and reliable. However, no responsibility is assumed by Same Sky for its use, nor for any infringements of patents or other rights of third parties which may result from its use.

Same Sky products are not authorized or warranted for use as critical components in equipment that requires an extremely high level of reliability. A critical component is any component of a life support device or system whose failure to perform can be reasonably expected to cause the failure of the life support device or system, or to affect its safety or effectiveness.

[sameskydevices.com](https://www.sameskydevices.com)