

MODEL: CMI-1275-03TH | **DESCRIPTION:** MAGNETIC BUZZER INDICATOR

FEATURES

- magnetic
- driving circuit
- through hole

SPECIFICATIONS

parameter	conditions/description	min	typ	max	units
rated voltage			3		Vdc
operating voltage		2		5	Vdc
current consumption	at 2,700 Hz, 3 Vdc			30	mA
rated frequency		2,400	2,700	3,000	Hz
sound pressure level	at 10 cm, 2,700 Hz, 3 Vdc	85			dB
tone	continuous				
dimensions	Ø12 x 7.5				mm
weight		1.5	1.6	1.7	g
material	PBT (UL94HB)				
terminal	pins (brass with tin plating)				
operating temperature		-20		70	°C
storage temperature		-30		80	°C
washable	yes				
RoHS	yes				

Notes: 1. All specifications measured at 25±3°C, humidity at 35-70%, under 86-106 kPa pressure, unless otherwise noted.

SOLDERABILITY

parameter	conditions/description	min	typ	max	units
hand soldering	for 2.0±1.0 seconds	340	350	360	°C
wave soldering	for 2±0.5 seconds	250	255	260	°C

MECHANICAL DRAWING

units: mm
tolerance: ± 0.5 mm

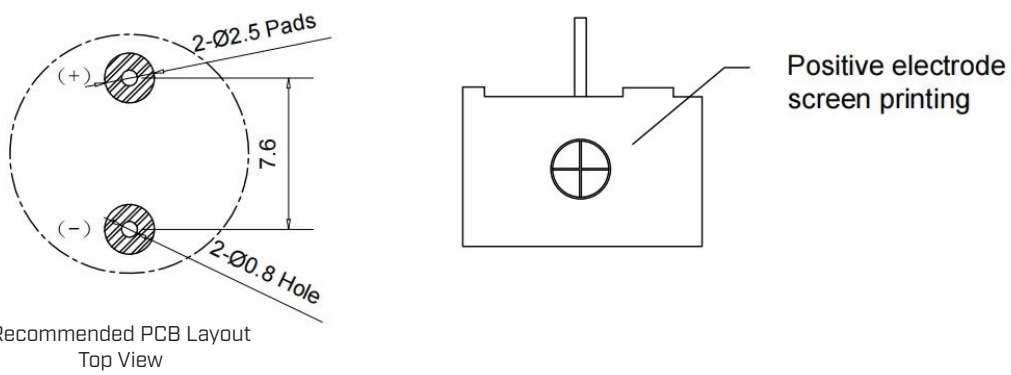
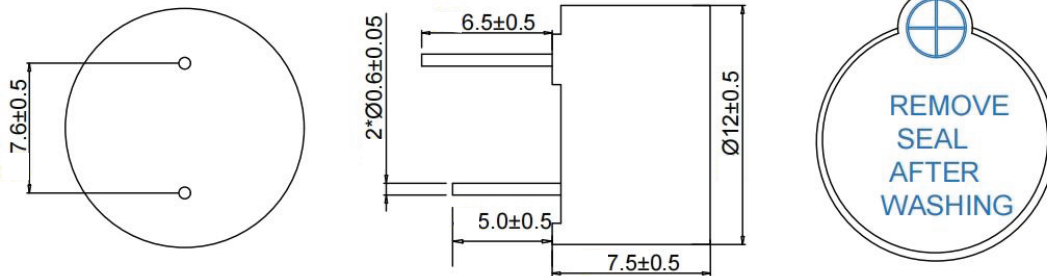

PERFORMANCE CURVES

Voltage vs. Sound Pressure Level at 10 cm

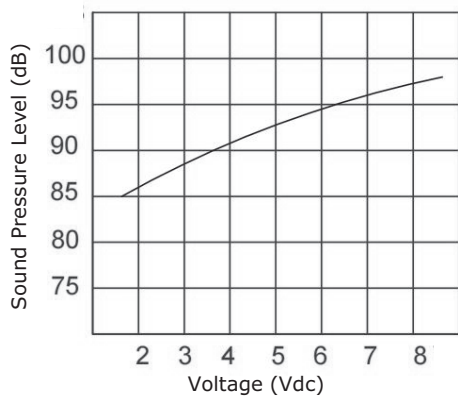

Voltage vs. Current Consumption

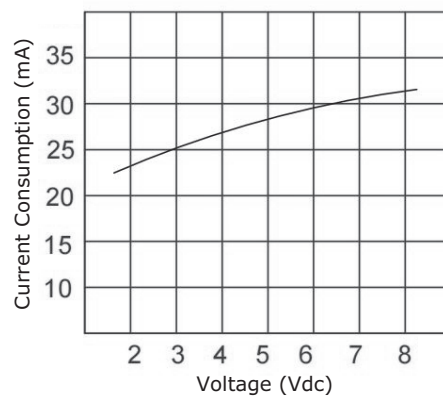

REVISION HISTORY

rev.	description	date
1.0	initial release	09/09/2024

The revision history provided is for informational purposes only and is believed to be accurate.



Same Sky offers a one (1) year limited warranty. Complete warranty information is listed on our website.

Same Sky reserves the right to make changes to the product at any time without notice. Information provided by Same Sky is believed to be accurate and reliable. However, no responsibility is assumed by Same Sky for its use, nor for any infringements of patents or other rights of third parties which may result from its use.

Same Sky products are not authorized or warranted for use as critical components in equipment that requires an extremely high level of reliability. A critical component is any component of a life support device or system whose failure to perform can be reasonably expected to cause the failure of the life support device or system, or to affect its safety or effectiveness.

[sameskydevices.com](https://www.sameskydevices.com)