

SERIES: CP60H | DESCRIPTION: PELTIER MODULE

FEATURES

- arcTEC™ structure on select models
- enhanced reliability for high thermal cycling
- superior thermal performance
- silicon sealed
- wide ΔT max
- low profile
- precise temperature control
- solid state construction



MODEL

| MODEL | input voltage ¹ | input current ² | internal resistance ³ | output Qmax ⁴ | | output ΔT max ⁵ | |
|---------------------------|----------------------------|----------------------------|----------------------------------|----------------------------|----------------------------|---|---|
| | max [Vdc] | max [A] | typ [$\Omega \pm 10\%$] | $T_h=27^\circ\text{C}$ [W] | $T_h=50^\circ\text{C}$ [W] | $T_h=27^\circ\text{C}$ [$^\circ\text{C}$] | $T_h=50^\circ\text{C}$ [$^\circ\text{C}$] |
| CP60131H | 3.8 | 6.0 | 0.45 | 13 | 14.3 | 70 | 77 |
| CP60139H | 2.1 | 6.0 | 0.30 | 7.4 | 8.2 | 70 | 77 |
| CP60231H | 8.8 | 6.0 | 1.05 | 29.7 | 32.7 | 70 | 77 |
| CP60239H | 3.8 | 6.0 | 0.55 | 13.6 | 14.9 | 70 | 77 |
| CP602040395H ⁶ | 7.6 | 6.0 | 1.09 | 27.5 | 30.2 | 70 | 77 |
| CP60301233H | 5.6 | 6.0 | 0.76 | 19.7 | 21.7 | 70 | 77 |
| CP60301531H | 7.6 | 6.0 | 0.93 | 26.3 | 28.9 | 70 | 77 |
| CP60302031H | 13.0 | 6.0 | 1.51 | 49.5 | 54.5 | 68 | 75 |
| CP603315H ⁶ | 15.7 | 6.0 | 1.90 | 53.1 | 59.1 | 70 | 77 |
| CP6030395 ⁶ | 11.8 | 6.0 | 1.65 | 41.5 | 45.6 | 70 | 77 |
| CP603395H ⁶ | 8.8 | 6.0 | 1.25 | 31.1 | 34.2 | 70 | 77 |
| CP604020395H ⁶ | 7.6 | 6.0 | 1.09 | 27.5 | 30.2 | 70 | 77 |
| CP60433H ⁶ | 19.5 | 6.0 | 2.54 | 67.6 | 74.3 | 68 | 75 |
| CP604395H ⁶ | 15.7 | 6.0 | 2.2 | 55.6 | 61.0 | 70 | 77 |
| CP604040 ⁶ | 24.1 | 6.0 | 3.21 | 83.5 | 91.9 | 68 | 75 |
| CP60546241 ⁶ | 41.3 | 6.0 | 5.78 | 147 | 161 | 70 | 77 |
| CP6055354 ⁶ | 35.4 | 6.0 | 4.95 | 126 | 138 | 70 | 77 |
| CP60555542 ⁶ | 29.8 | 6.0 | 4.15 | 106 | 116 | 70 | 77 |
| CP604060395 ⁶ | 23.6 | 6.0 | 3.3 | 80.2 | 88.2 | 70 | 77 |

Notes: 1. Maximum voltage at ΔT max and $T_h=27^\circ\text{C}$
 2. Maximum current to achieve ΔT max
 3. Measured by AC 4-terminal method at 25°C
 4. Maximum heat absorbed at cold side occurs at I_{max} , V_{max} , and $\Delta T=0^\circ\text{C}$
 5. Maximum temperature difference occurs at I_{max} , V_{max} , and $Q=0\text{W}$ [ΔT max measured in a vacuum at 1.3 Pa]
 6. Designed with arcTEC™ structure.

SPECIFICATIONS

| parameter | conditions/description | min | typ | max | units |
|----------------------------|---|-----|-----|-----|-------|
| solder melting temperature | connection between thermoelectric pairs | 235 | | | °C |
| assembly compression | | | | 1 | MPa |
| RoHS | yes | | | | |

MECHANICAL DRAWING

units: mm

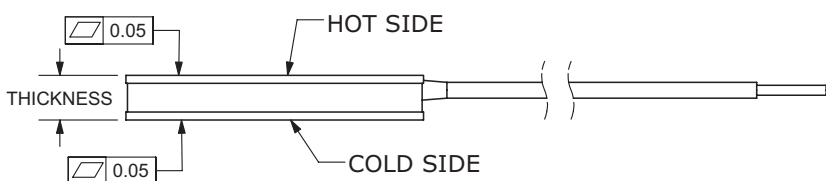

| | MATERIAL | PLATING |
|---|---|---------|
| ceramic plate | 96% AL ₂ O ₃ | |
| wire leads (CP60131H, CP60231H, CP60302031H, CP60301233H, CP60301531H, CP603315H) | 22 AWG | tin |
| wire leads (all other models) | 20 AWG | tin |
| sealer | silicon rubber 703 RTV (between cold and hot side plates) | |
| joint cover | silicon rubber 703 RTV | |
| marking | P/N & S/N printed on cold side surface | |

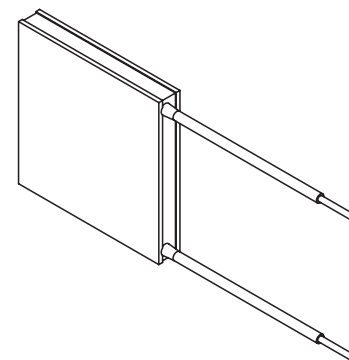
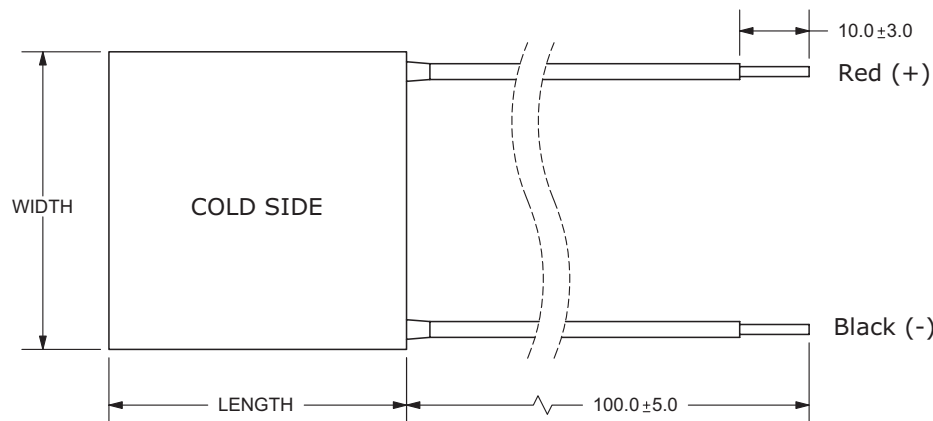

| MODEL NO. | LENGTH [mm] | WIDTH [mm] | THICKNESS [mm] | MODEL NO. | LENGTH [mm] | WIDTH [mm] | THICKNESS [mm] |
|--------------|-------------|------------|----------------|--------------|-------------|------------|----------------|
| CP60131H | 15 ±0.3 | 15 ±0.3 | 3.1 ±0.025 | CP603395H | 30 ±0.3 | 30 ±0.3 | 3.95 ±0.025 |
| CP60139H | 15 ±0.3 | 15 ±0.3 | 3.9 ±0.025 | CP604020395H | 40 ±0.3 | 20 ±0.3 | 3.95 ±0.025 |
| CP60231H | 20 ±0.3 | 20 ±0.3 | 3.1 ±0.025 | CP60433H | 40 ±0.3 | 40 ±0.3 | 3.3 ±0.03 |
| CP60239H | 20 ±0.3 | 20 ±0.3 | 3.9 ±0.025 | CP604395H | 40 ±0.3 | 40 ±0.3 | 3.95 ±0.025 |
| CP602040395H | 20 ±0.3 | 40 ±0.3 | 3.95 ±0.025 | CP604040 | 40 ±0.3 | 40 ±0.3 | 4.0 ±0.1 |
| CP60301233H | 30 ±0.1 | 12 ±0.1 | 3.3 ±0.1 | CP60546241 | 62.5 ±0.3 | 54 ±0.3 | 4.1 ±0.1 |
| CP60301531H | 30 ±0.3 | 15 ±0.3 | 3.1 ±0.025 | CP6055354 | 55 ±0.3 | 55 ±0.3 | 4.1 ±0.1 |
| CP60302031H | 30 ±0.3 | 20 ±0.3 | 3.1 ±0.1 | CP6055542 | 55 ±0.3 | 55 ±0.3 | 4.2 ±0.1 |
| CP603315H | 30 ±0.3 | 30 ±0.3 | 3.15 ±0.025 | CP604060395 | 40 ±0.3 | 60 ±0.3 | 3.95 ±0.025 |
| CP6030395 | 30 ±0.3 | 30 ±0.3 | 3.95 ±0.025 | | | | |

CP60131H PERFORMANCE (Th=27°C)

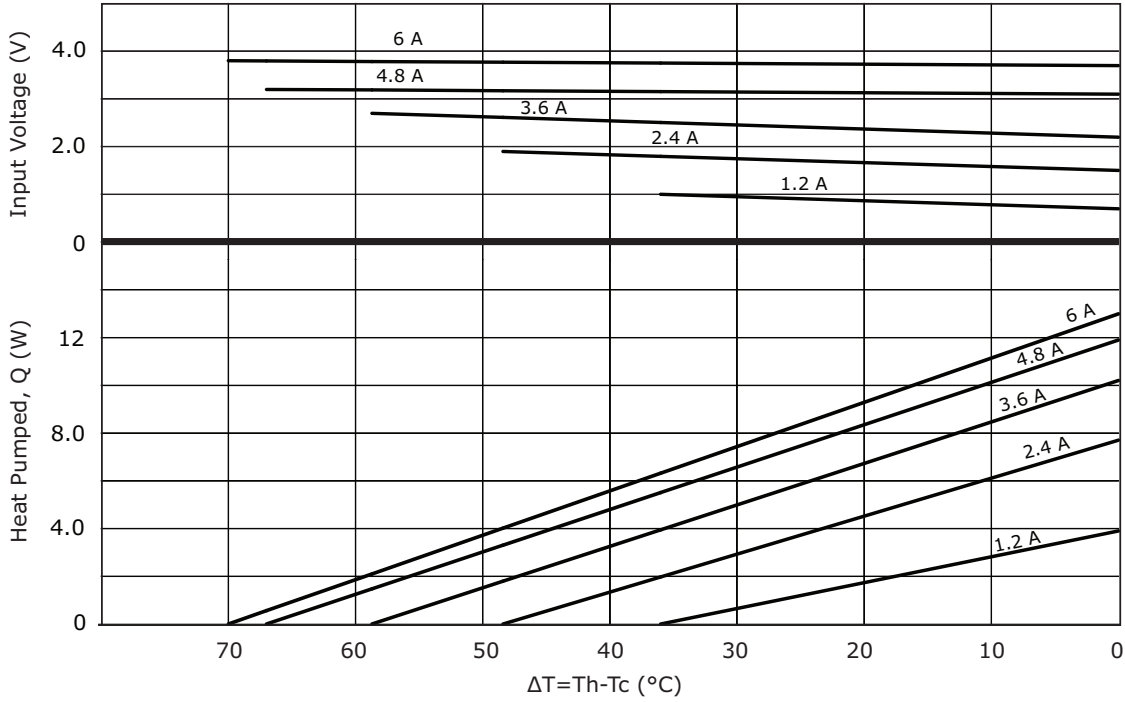

CP60131H PERFORMANCE (Th=50°C)

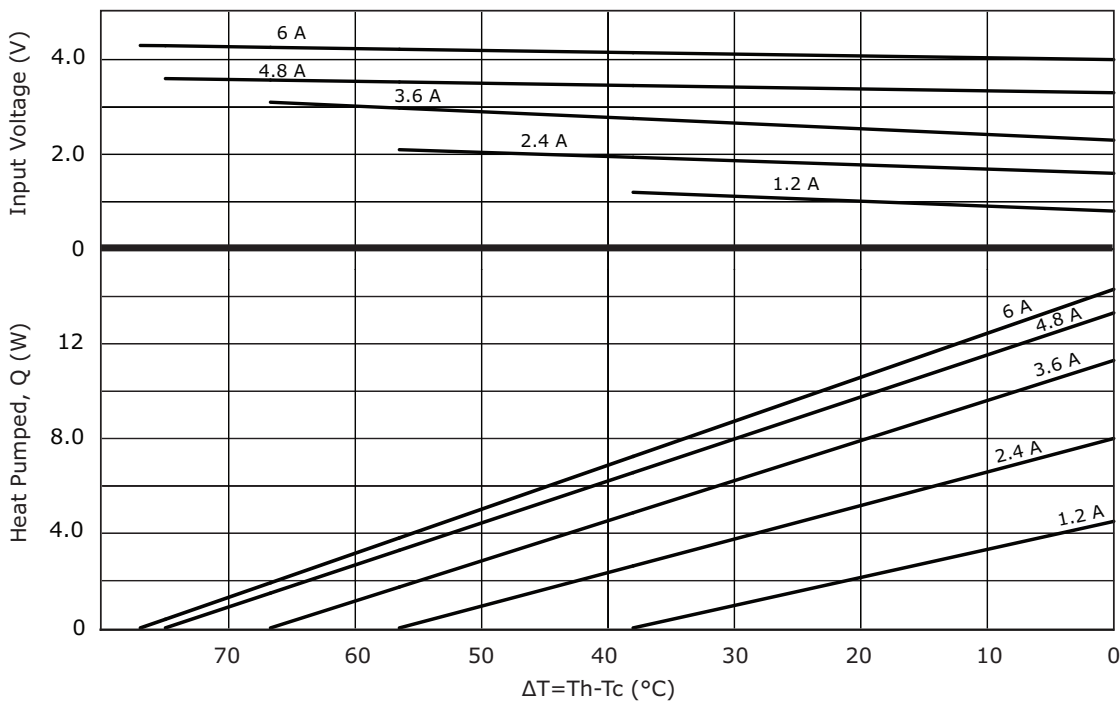

CP60139H PERFORMANCE (Th=27°C)



CP60139H PERFORMANCE (Th=50°C)

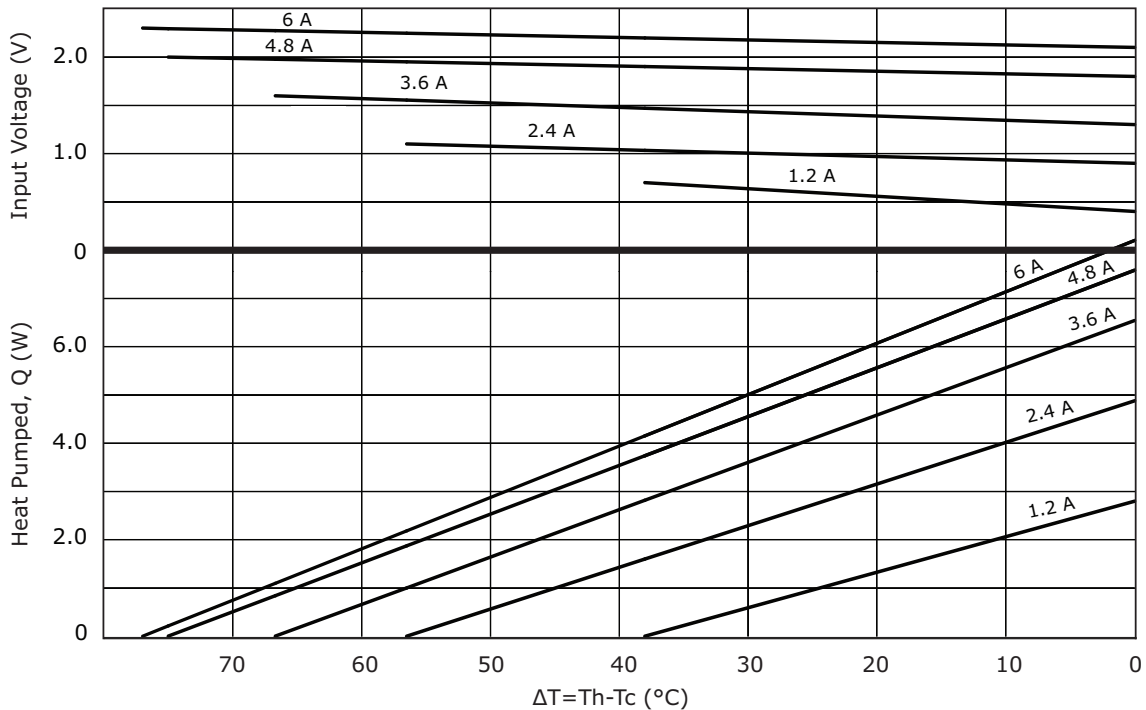

CP60231H PERFORMANCE (Th=27°C)

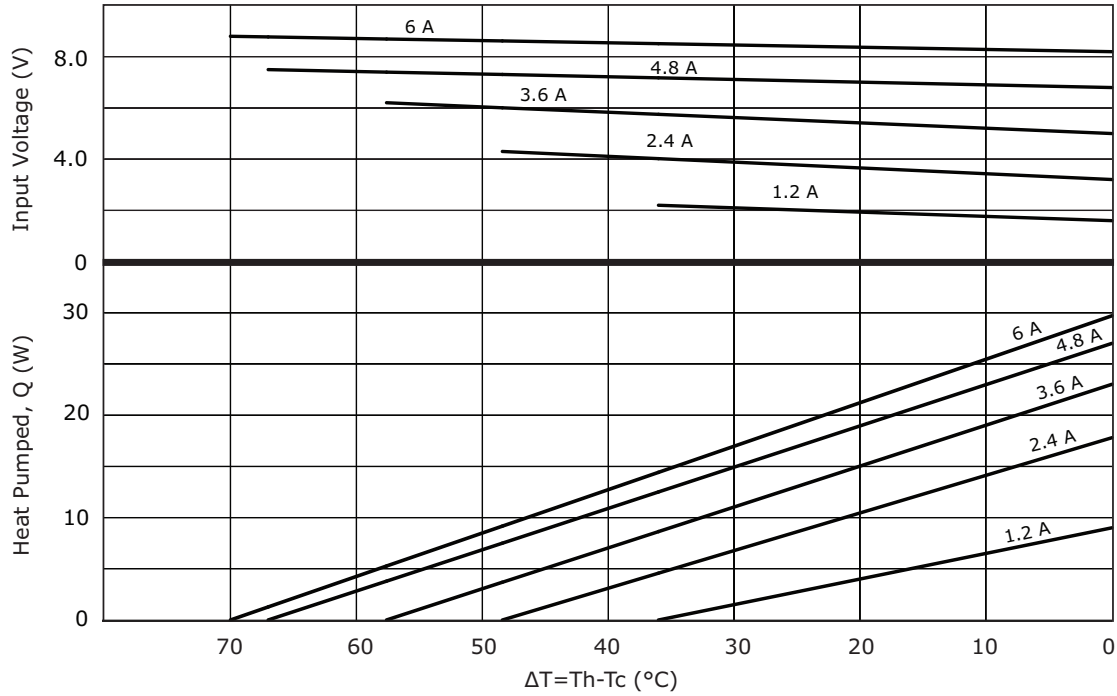

CP60231H PERFORMANCE (Th=50°C)

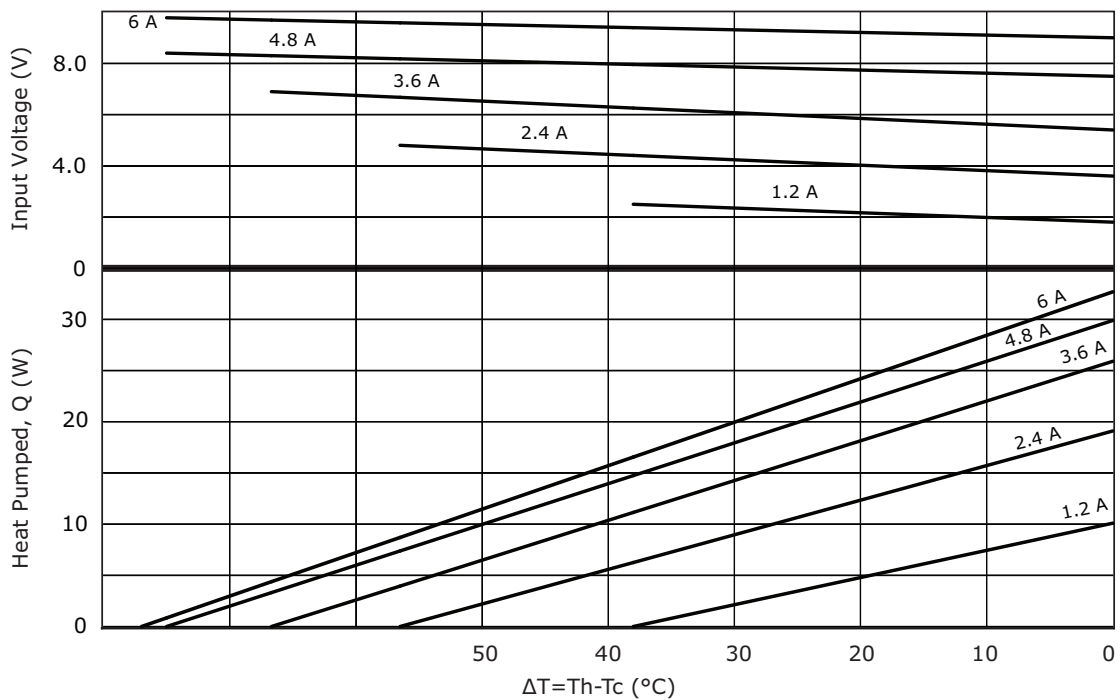

CP60239H PERFORMANCE (Th=27°C)

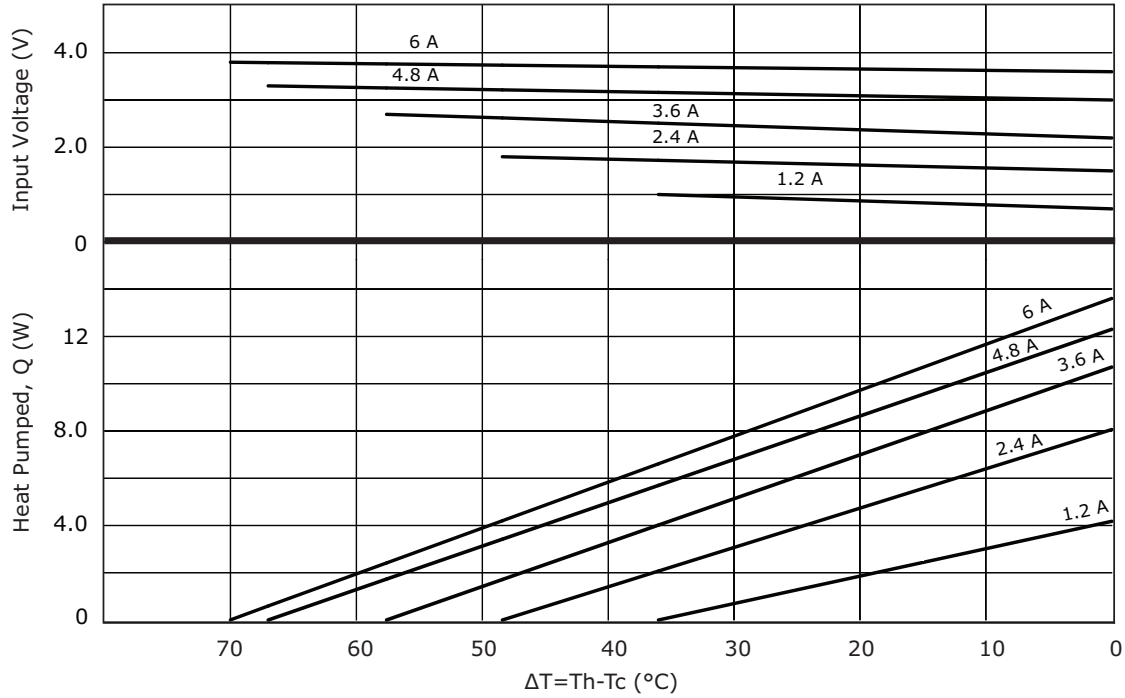

CP60239H PERFORMANCE (Th=50°C)

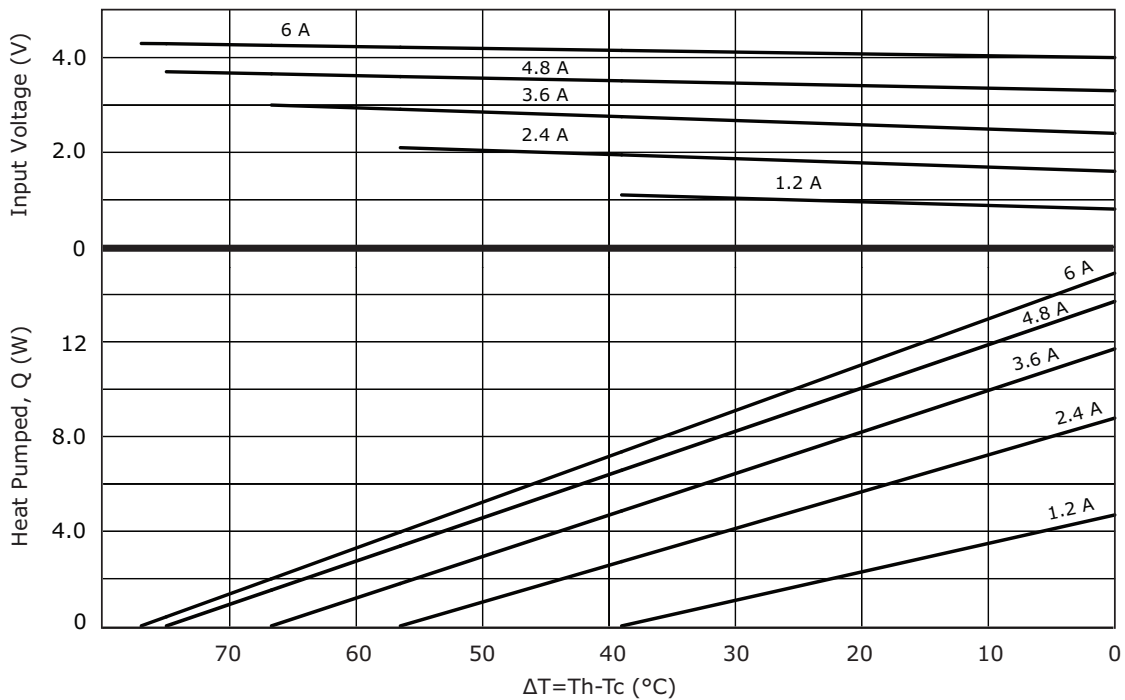

CP602040395H PERFORMANCE (Th=27°C)



CP602040395H PERFORMANCE (Th=50°C)

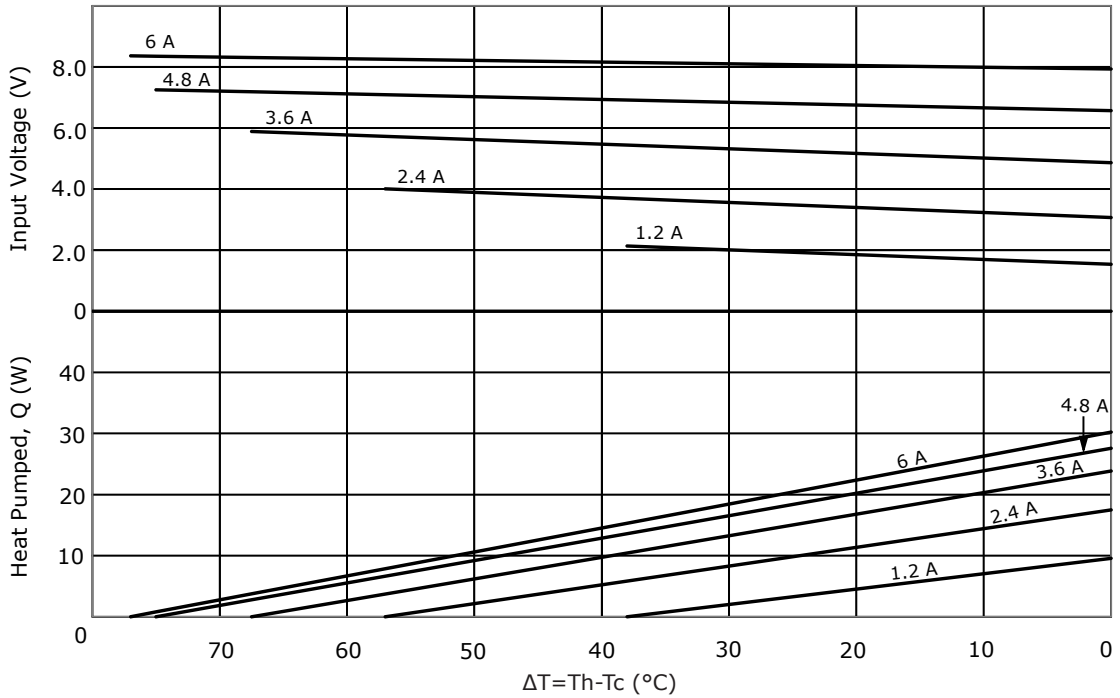

CP60301233H PERFORMANCE (Th=27°C)

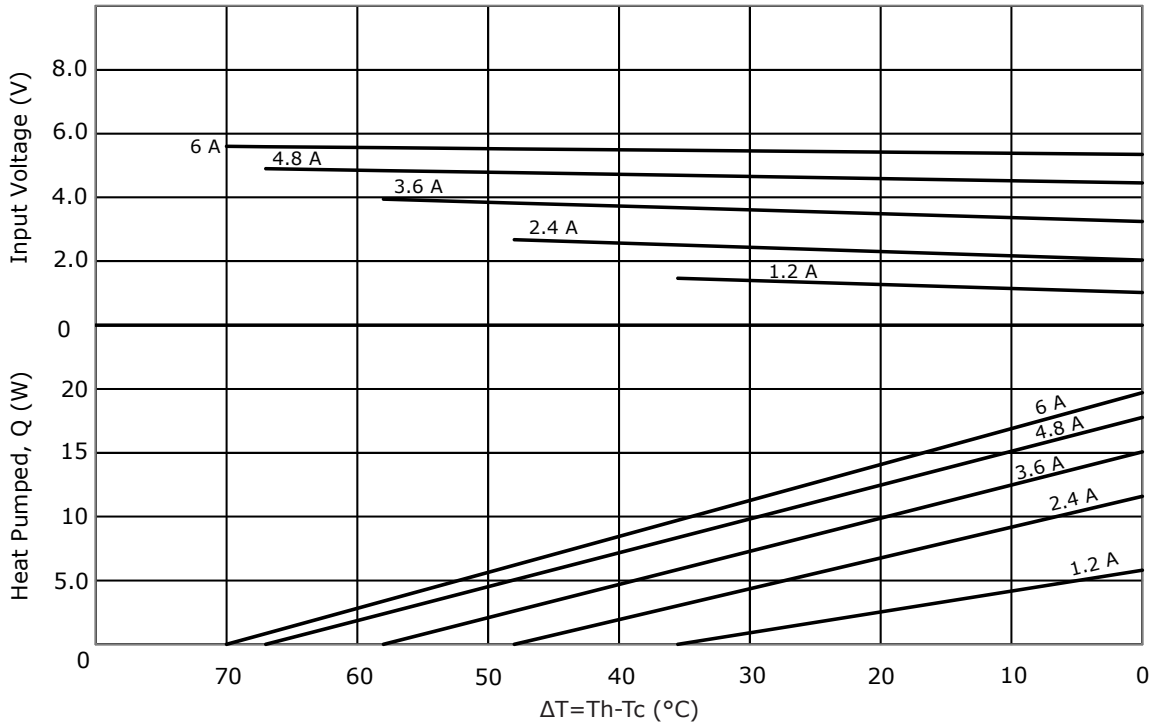

CP60301233H PERFORMANCE (Th=50°C)

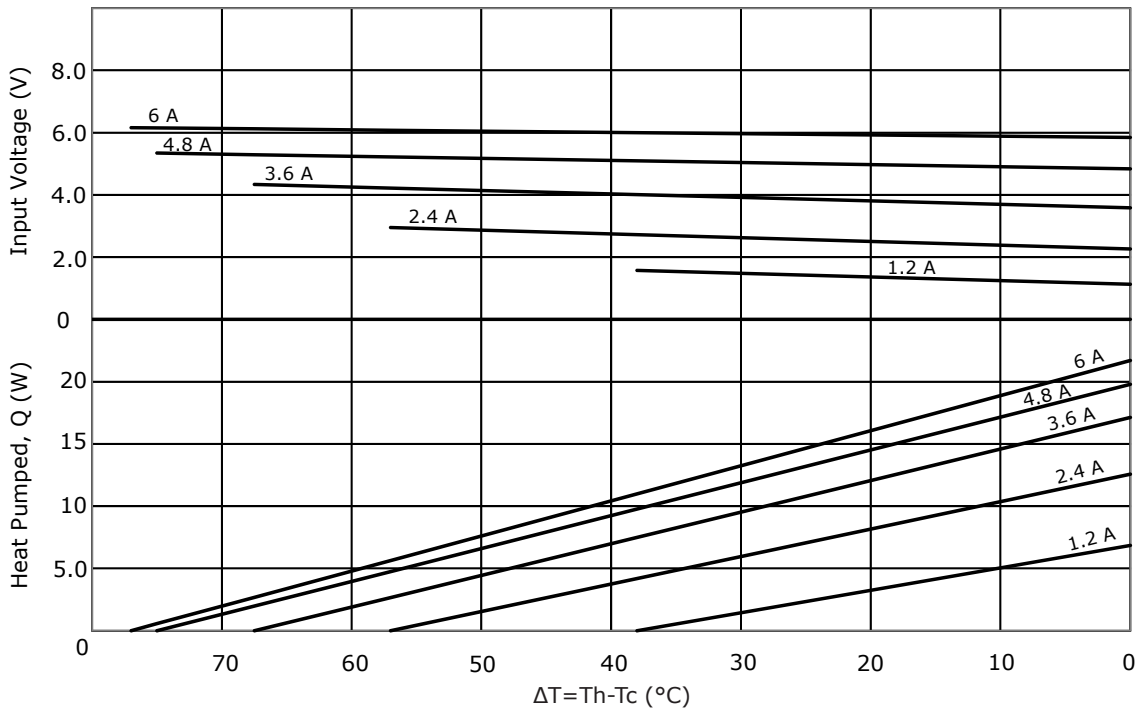

CP60301531H PERFORMANCE (Th=27°C)

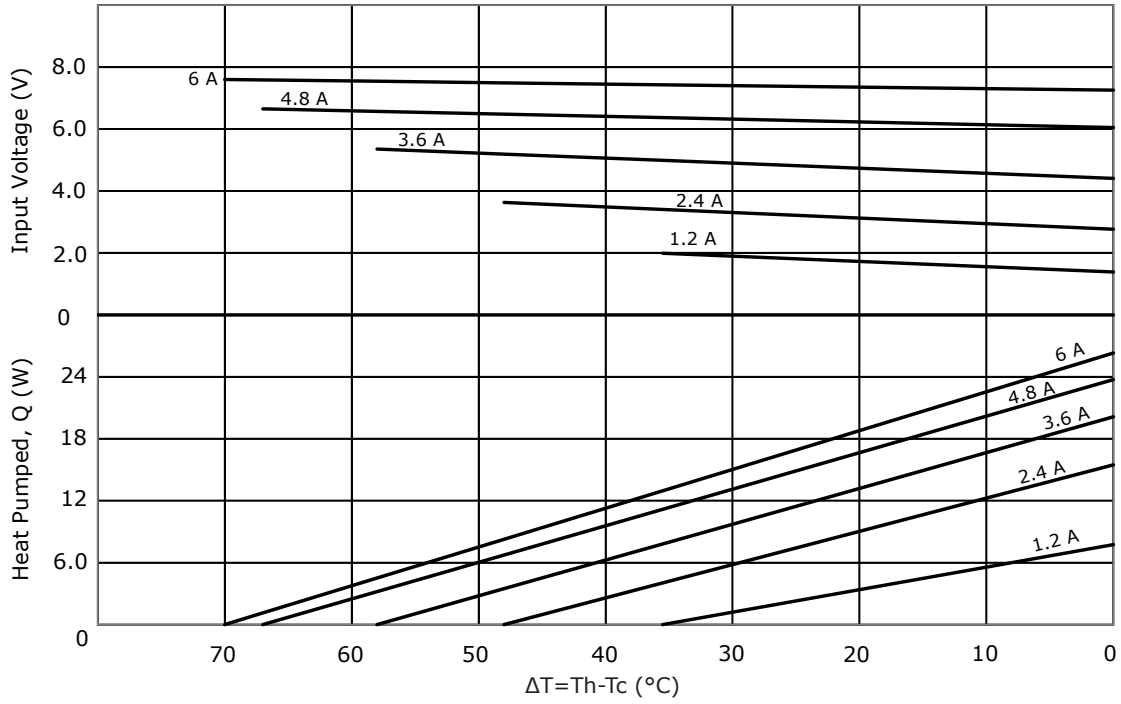

CP60301531H PERFORMANCE (Th=50°C)

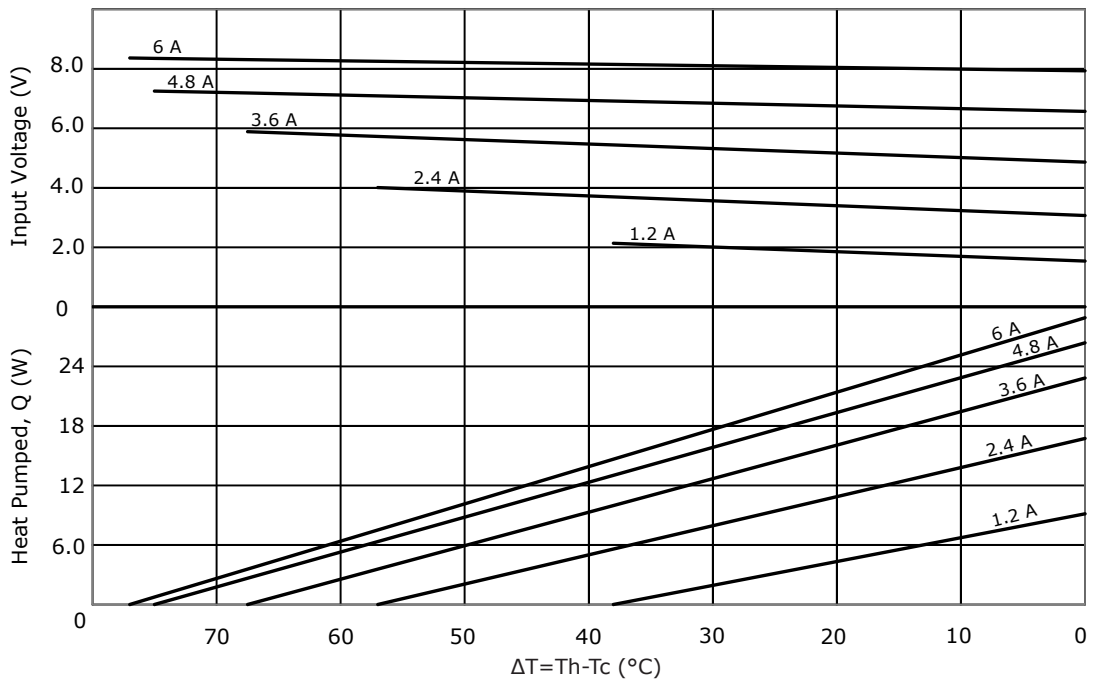

CP60302031H PERFORMANCE (Th=27°C)

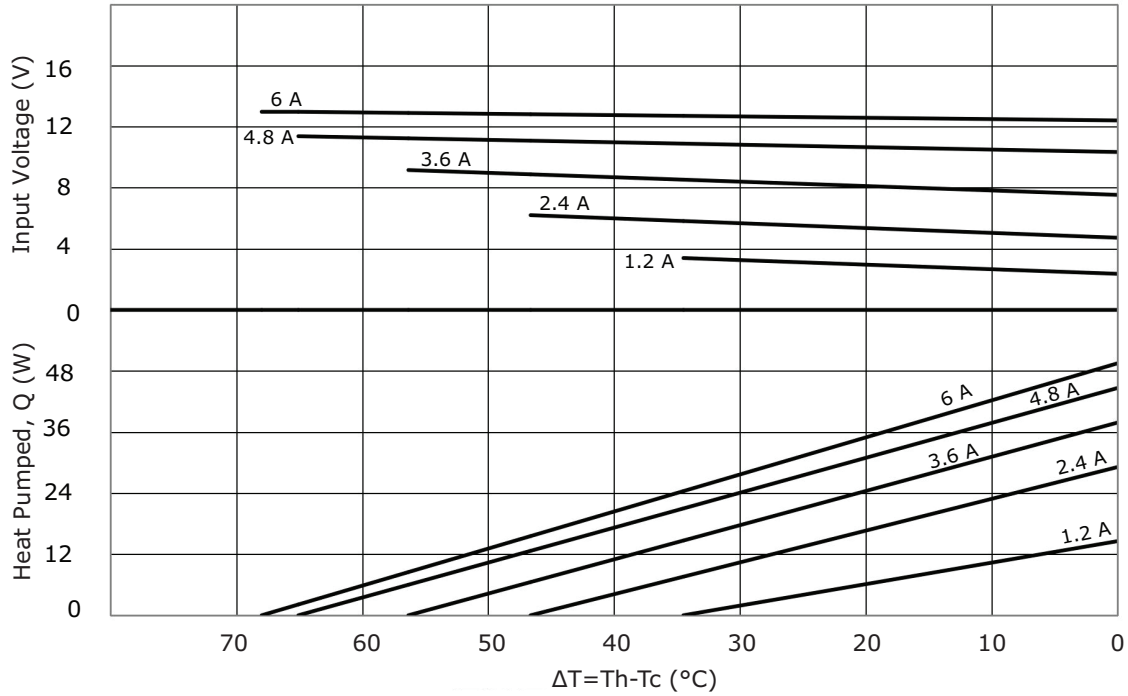

CP60302031H PERFORMANCE (Th=50°C)

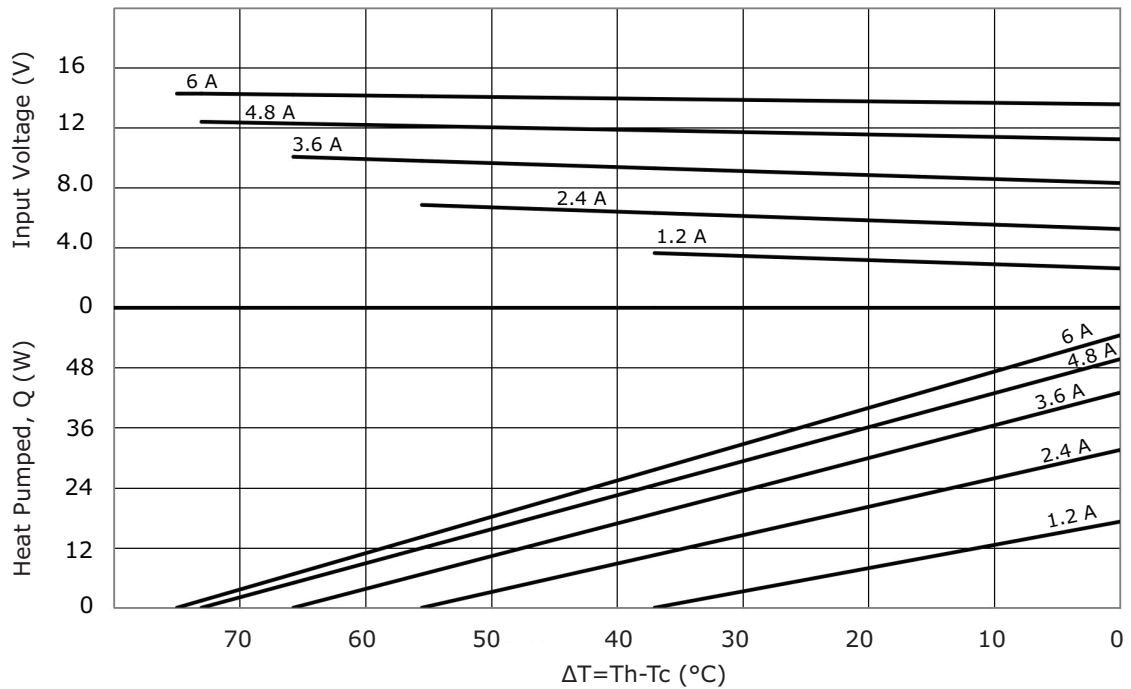

CP603315H PERFORMANCE (Th=27°C)

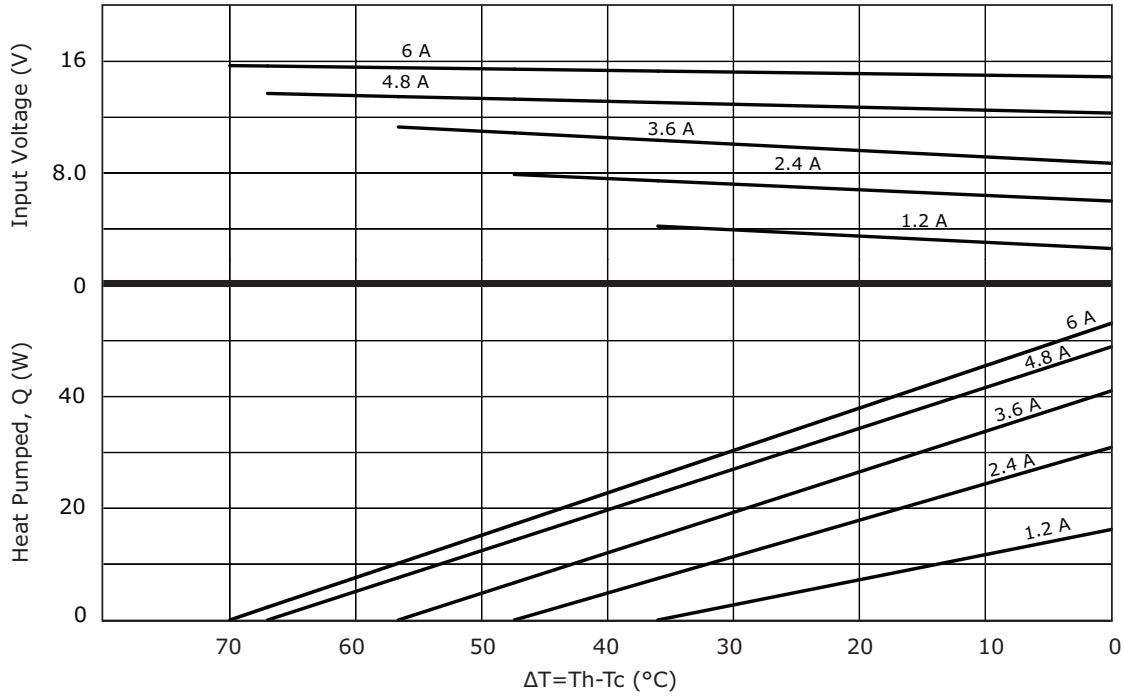

CP603315H PERFORMANCE (Th=50°C)

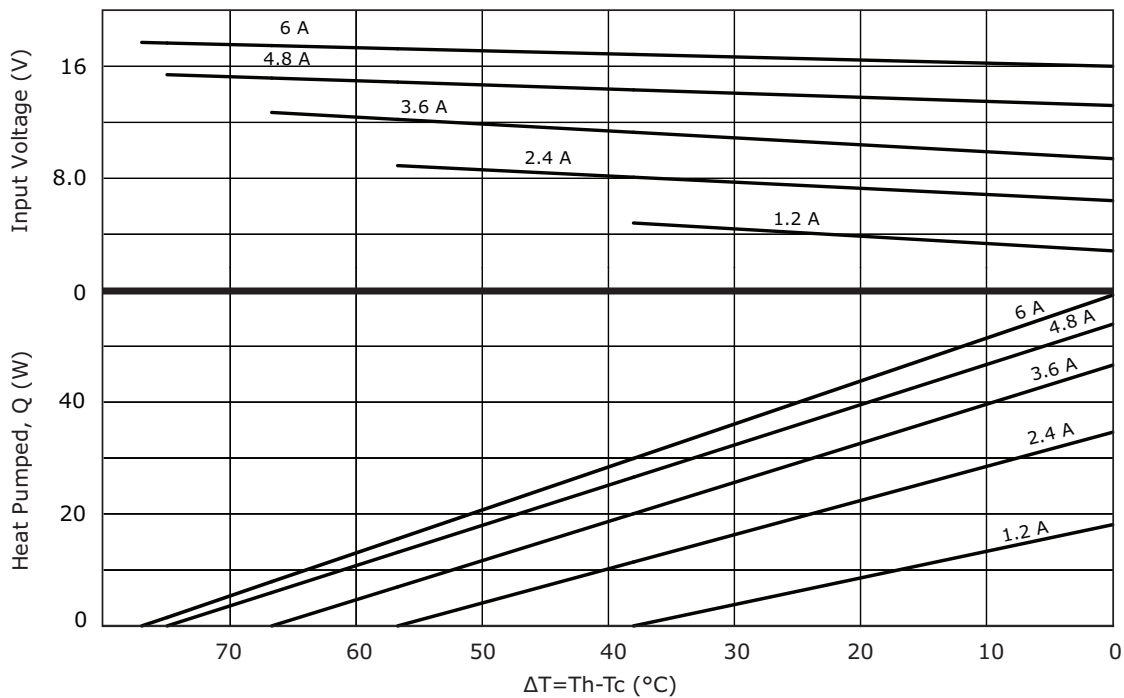

CP6030395 PERFORMANCE (Th=27°C)

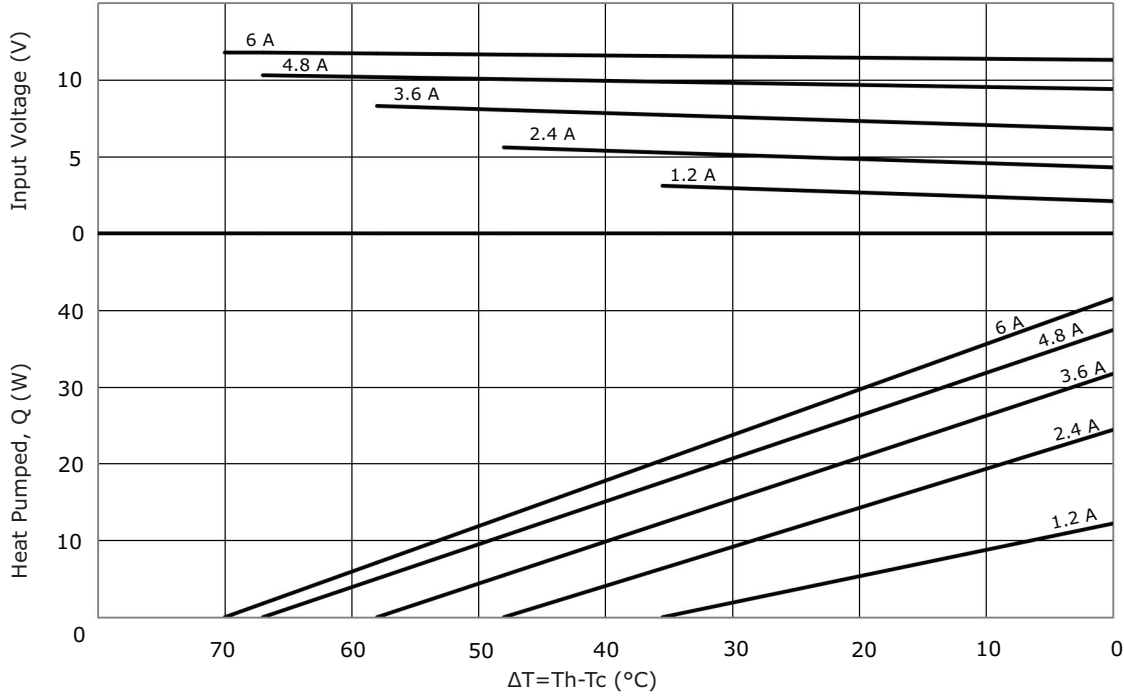

CP6030395 PERFORMANCE (Th=50°C)

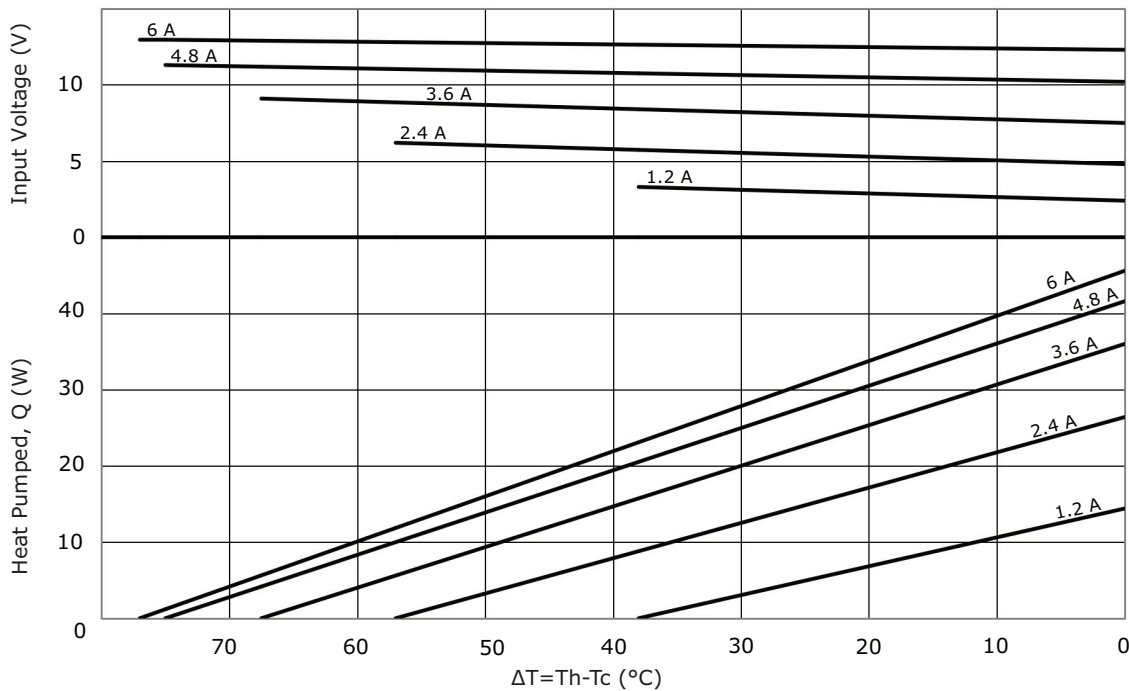

CP603395H PERFORMANCE (Th=27°C)

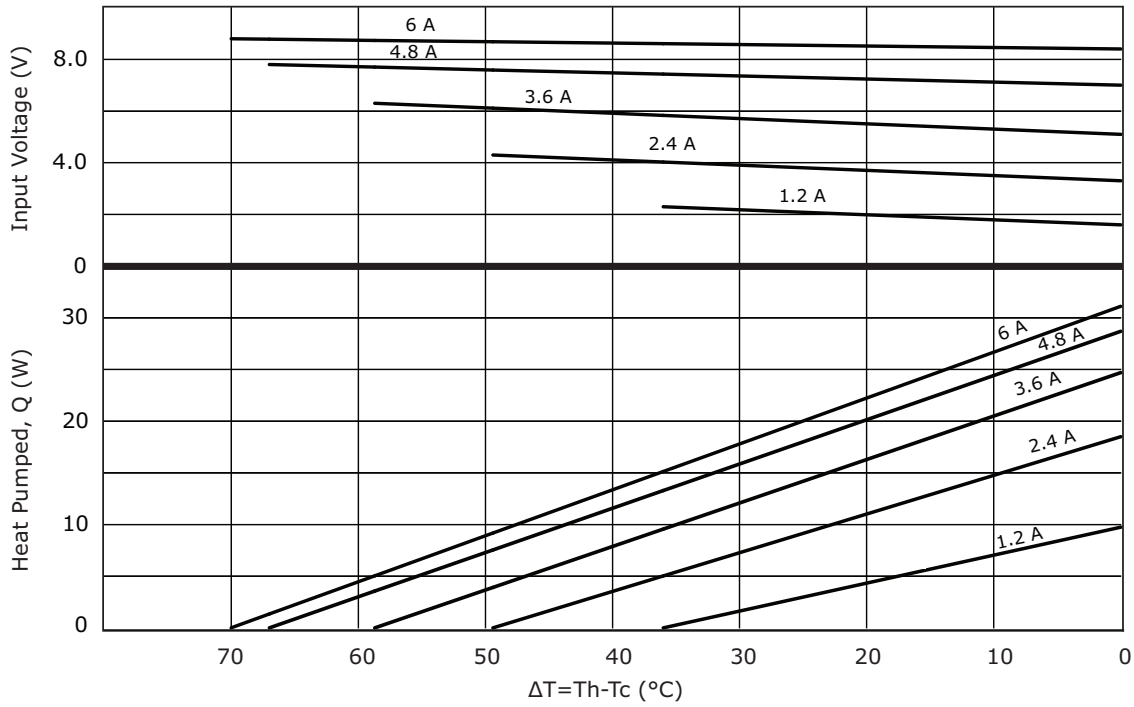

CP603395H PERFORMANCE (Th=50°C)

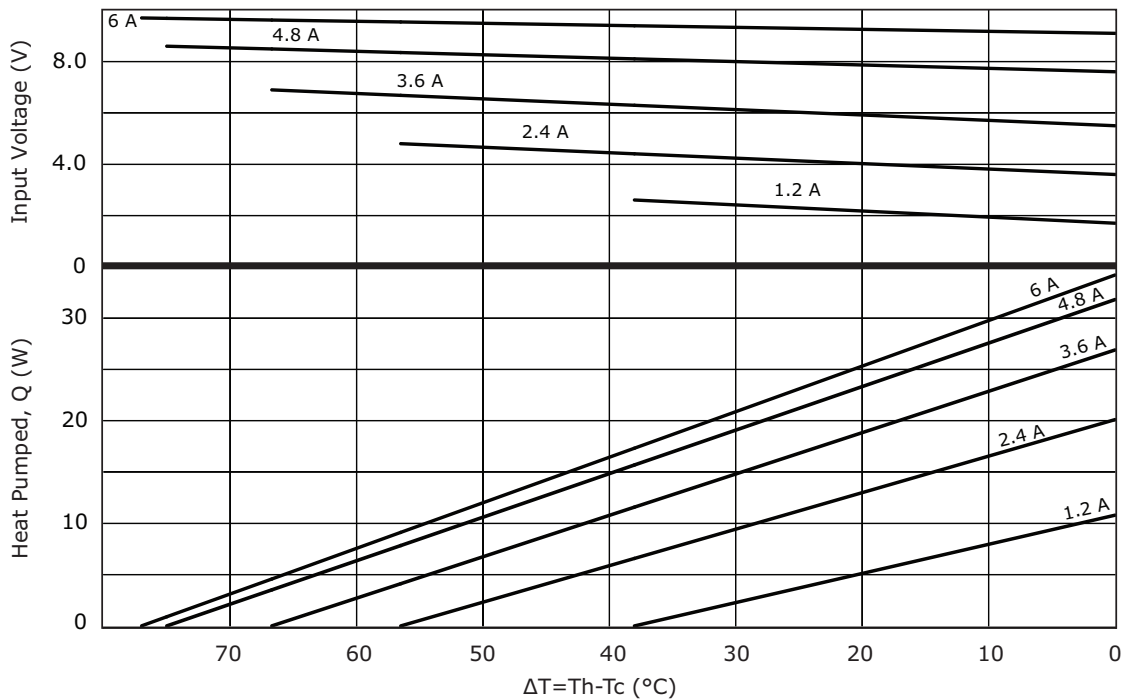

CP604020395H PERFORMANCE (Th=27°C)

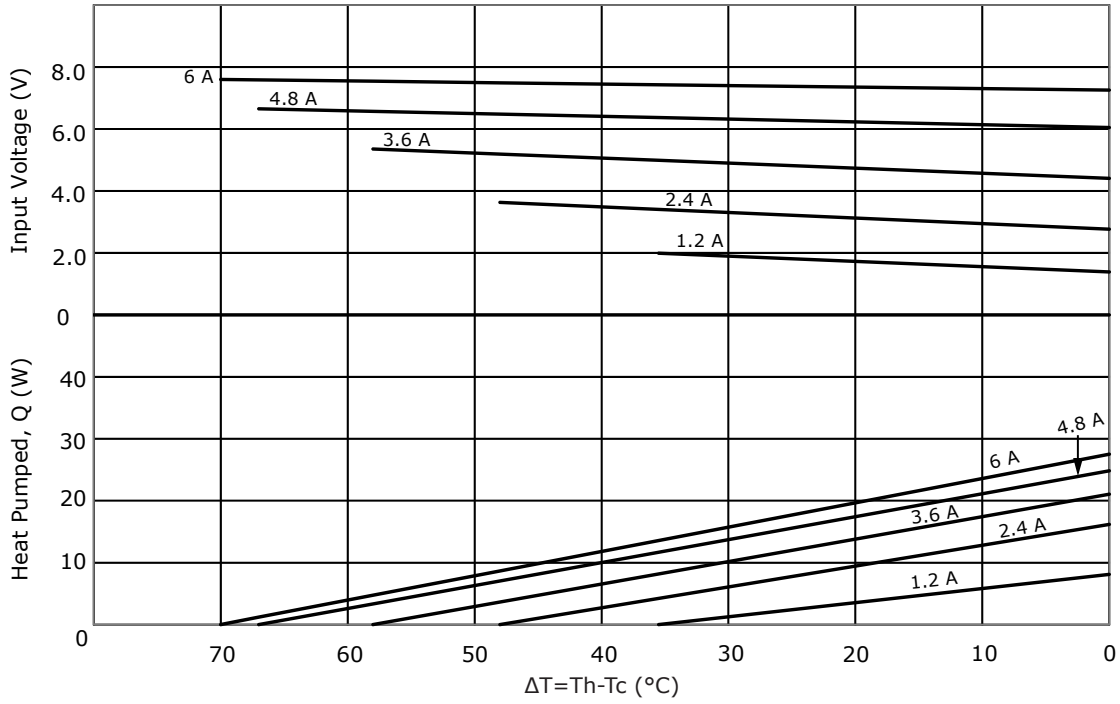

CP604020395H PERFORMANCE (Th=50°C)

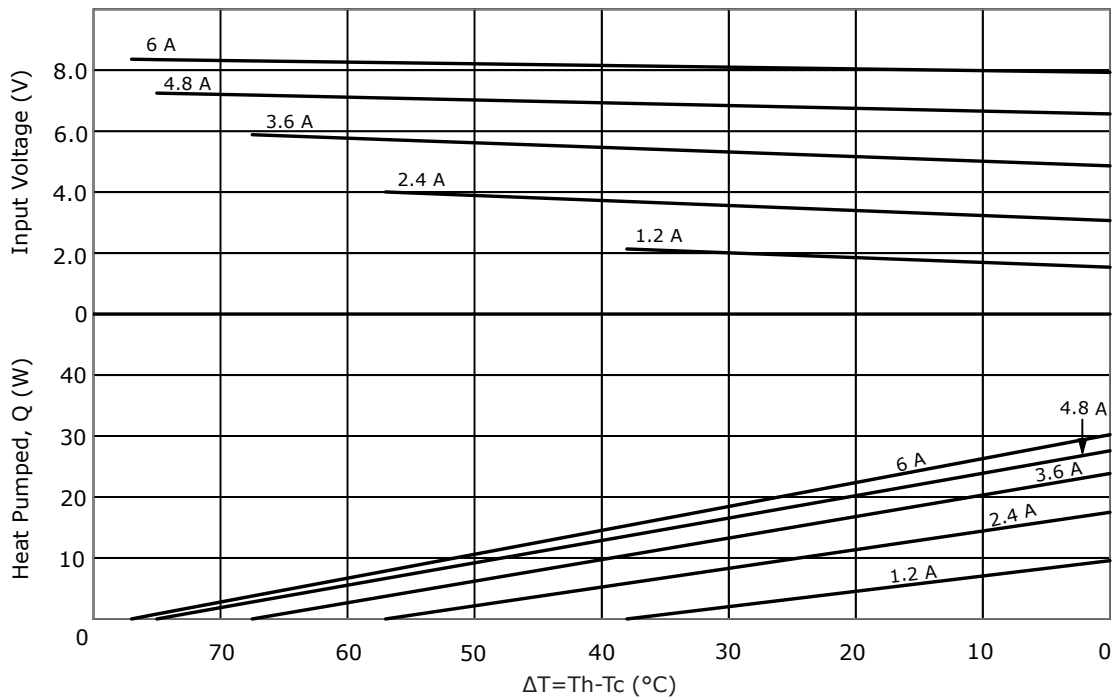

CP60433H PERFORMANCE (Th=27°C)

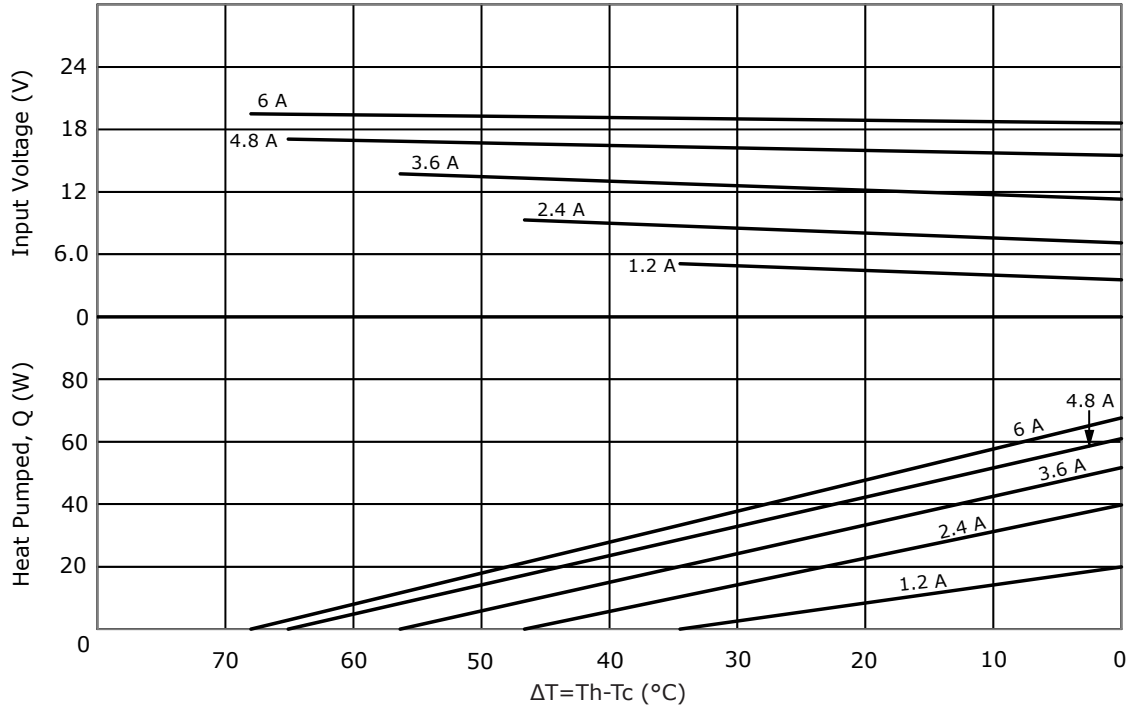

CP60433H PERFORMANCE (Th=50°C)

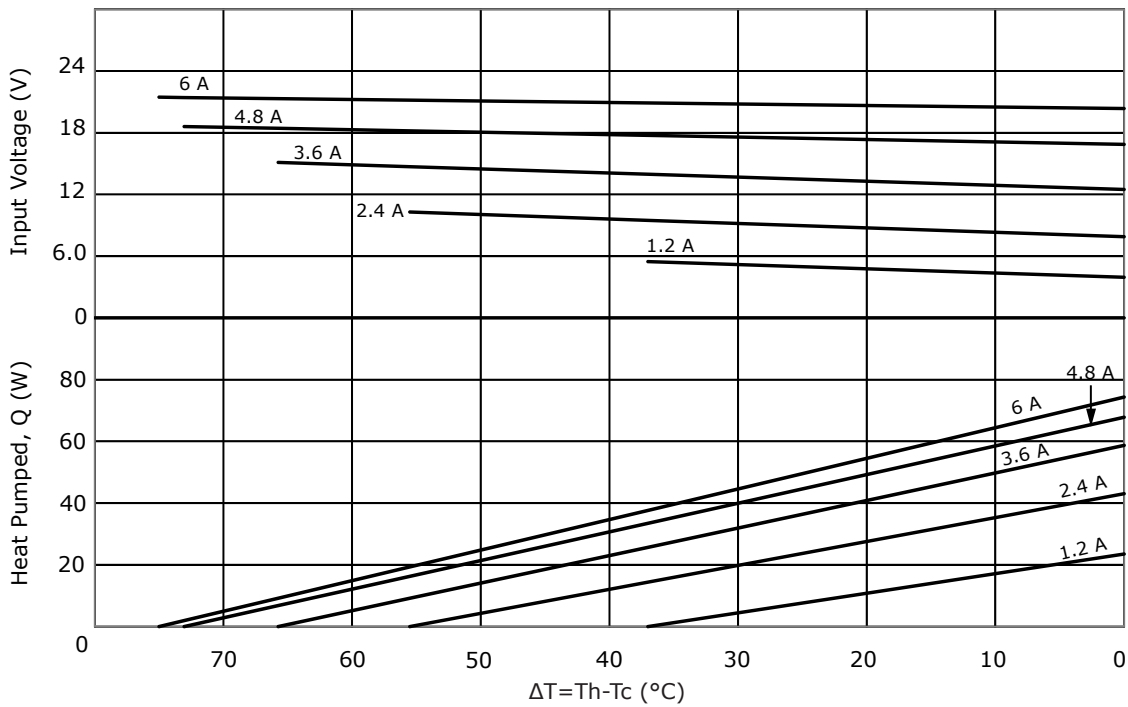

CP604395H PERFORMANCE (Th=27°C)

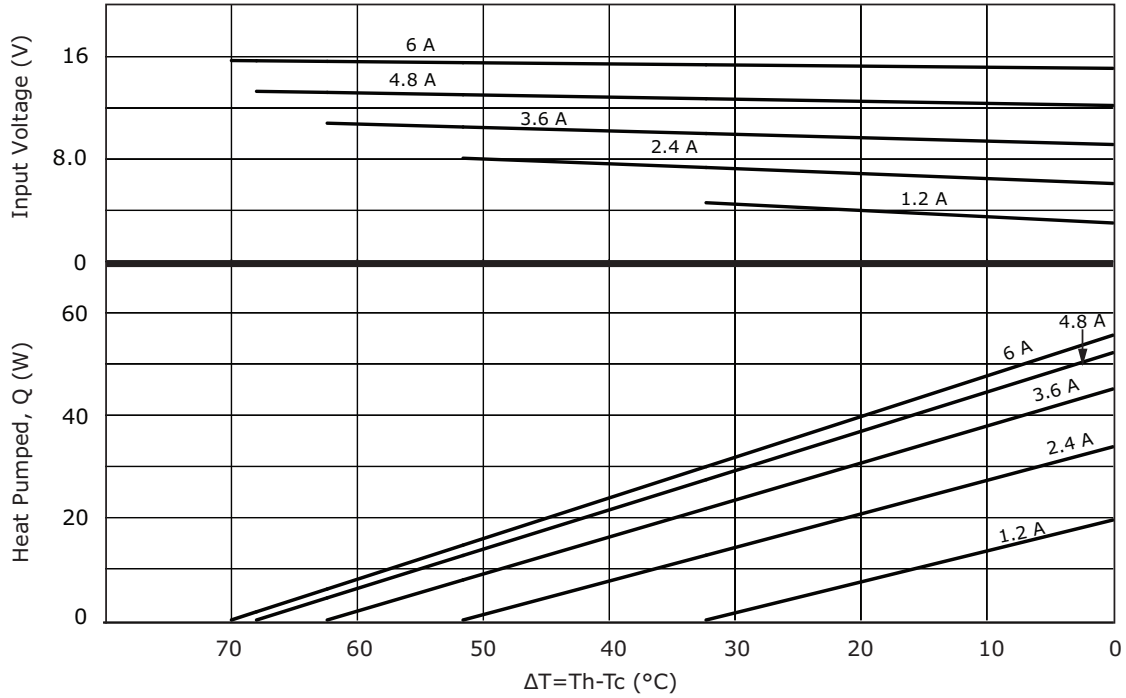

CP604395H PERFORMANCE (Th=50°C)

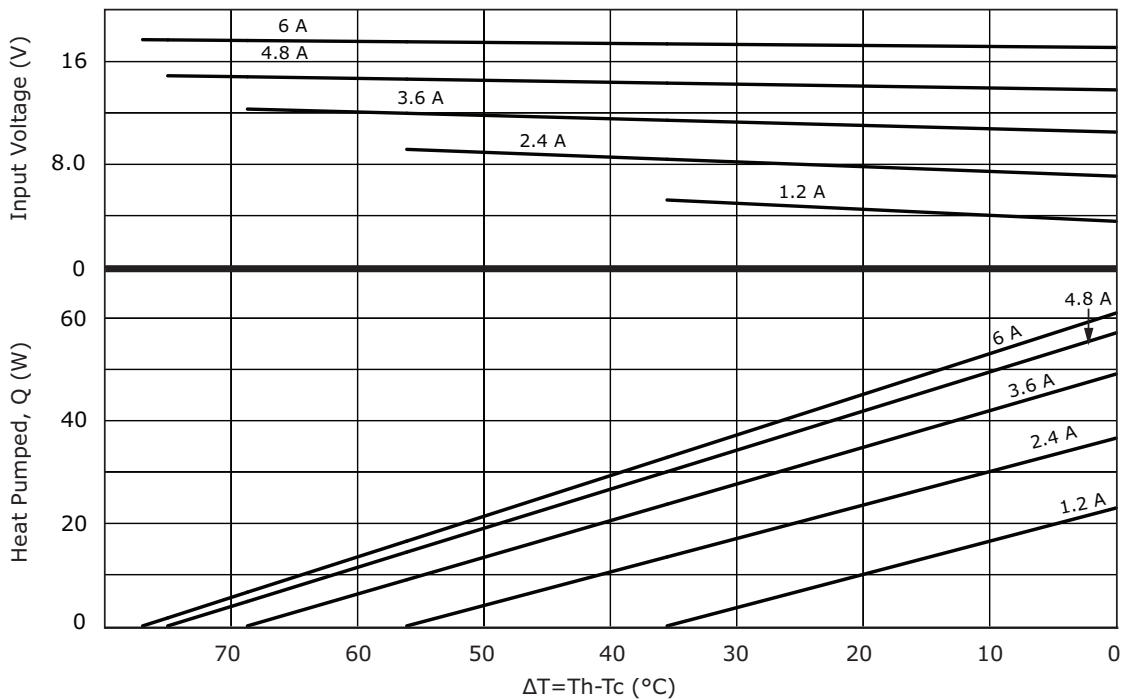

CP604040 PERFORMANCE (Th=27°C)

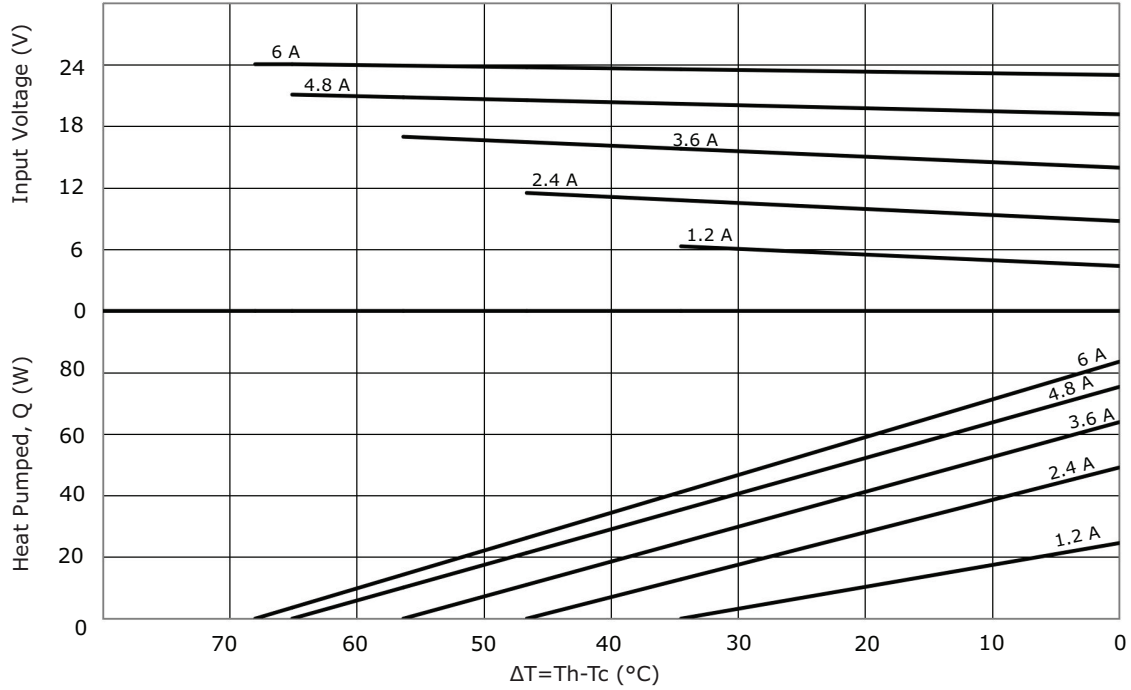

CP604040 PERFORMANCE (Th=50°C)

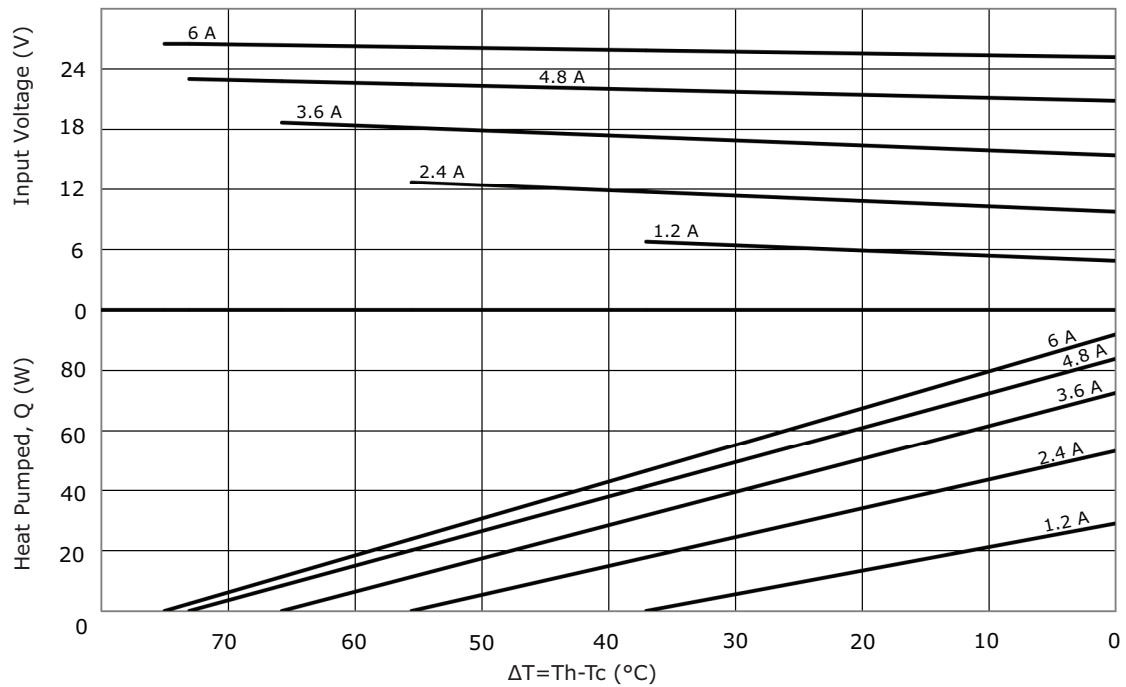

CP60546241 PERFORMANCE (Th=27°C)

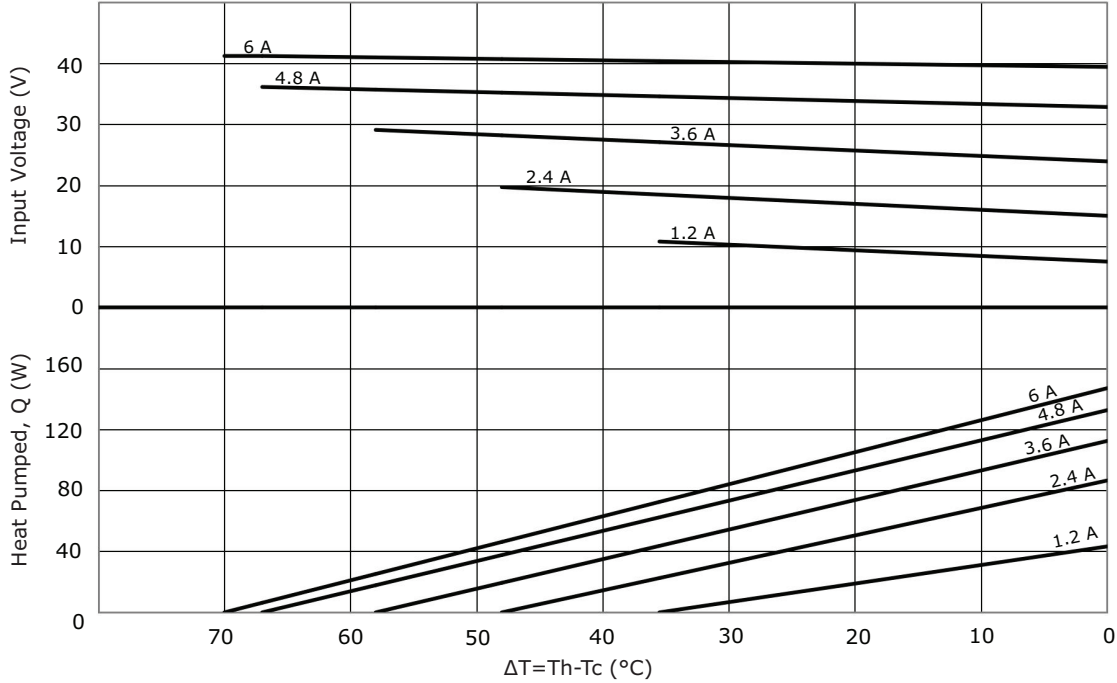

CP60546241 PERFORMANCE (Th=50°C)

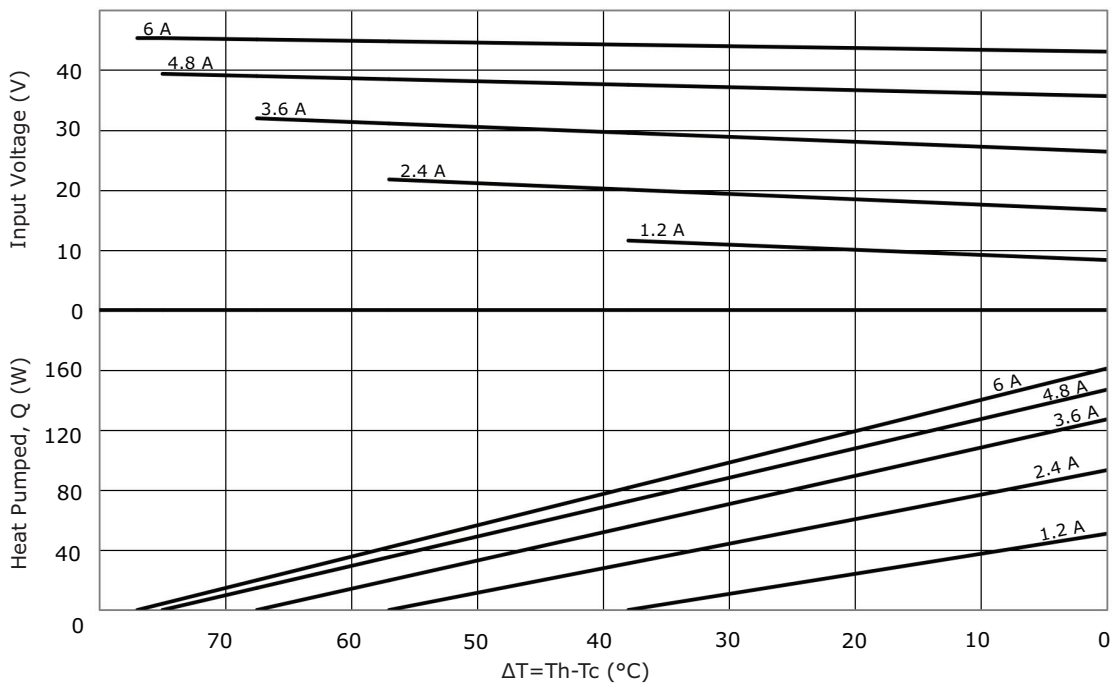

CP605354 PERFORMANCE (Th=27°C)

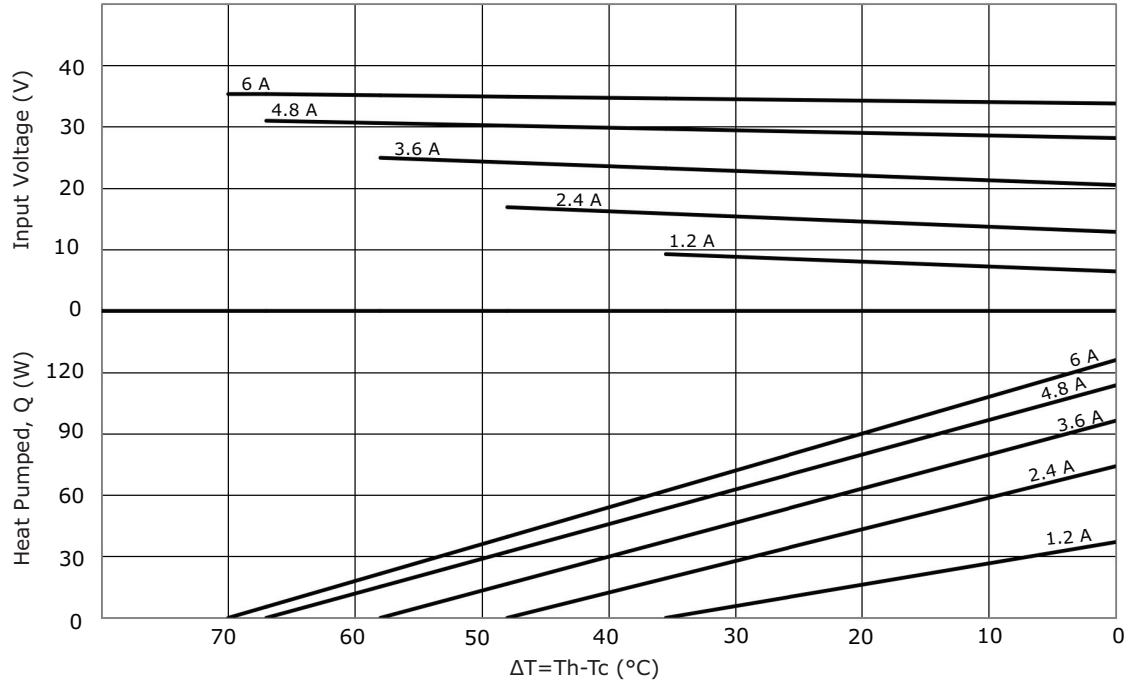

CP605354 PERFORMANCE (Th=50°C)

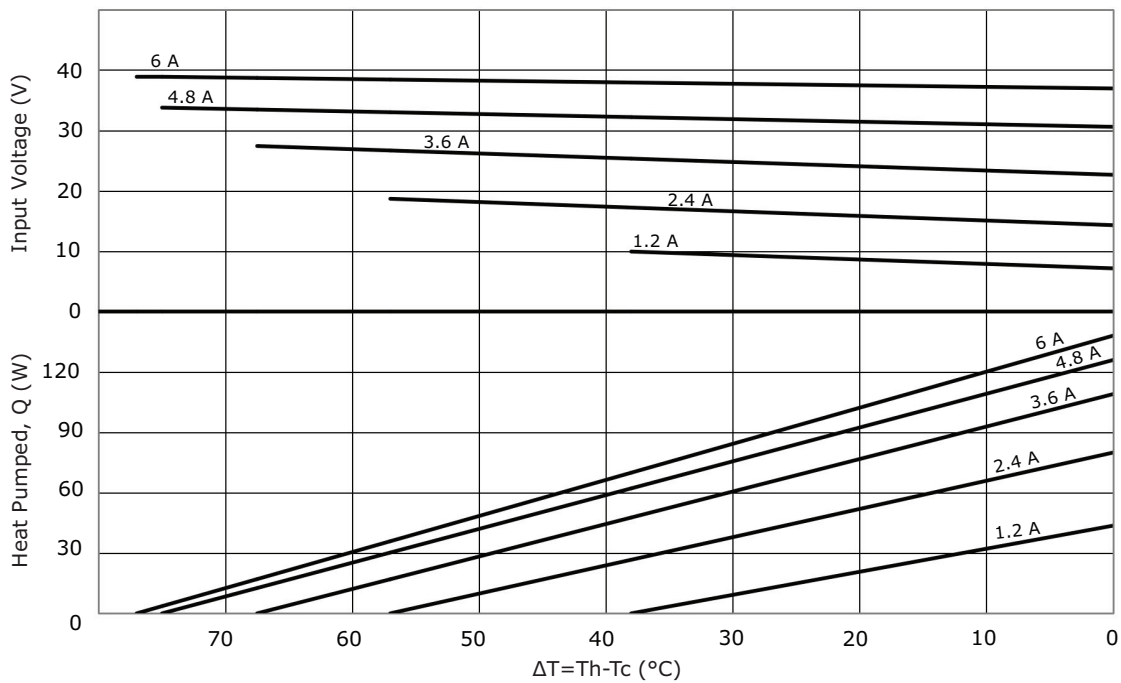

CP6055542 PERFORMANCE (Th=27°C)

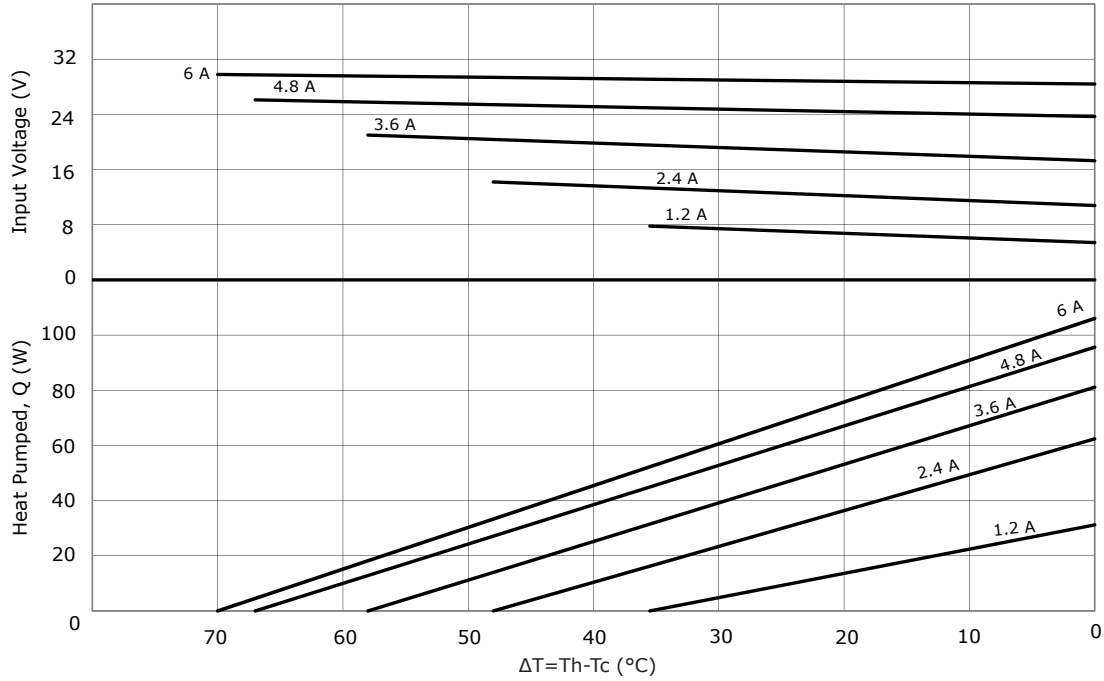

CP6055542 PERFORMANCE (Th=50°C)

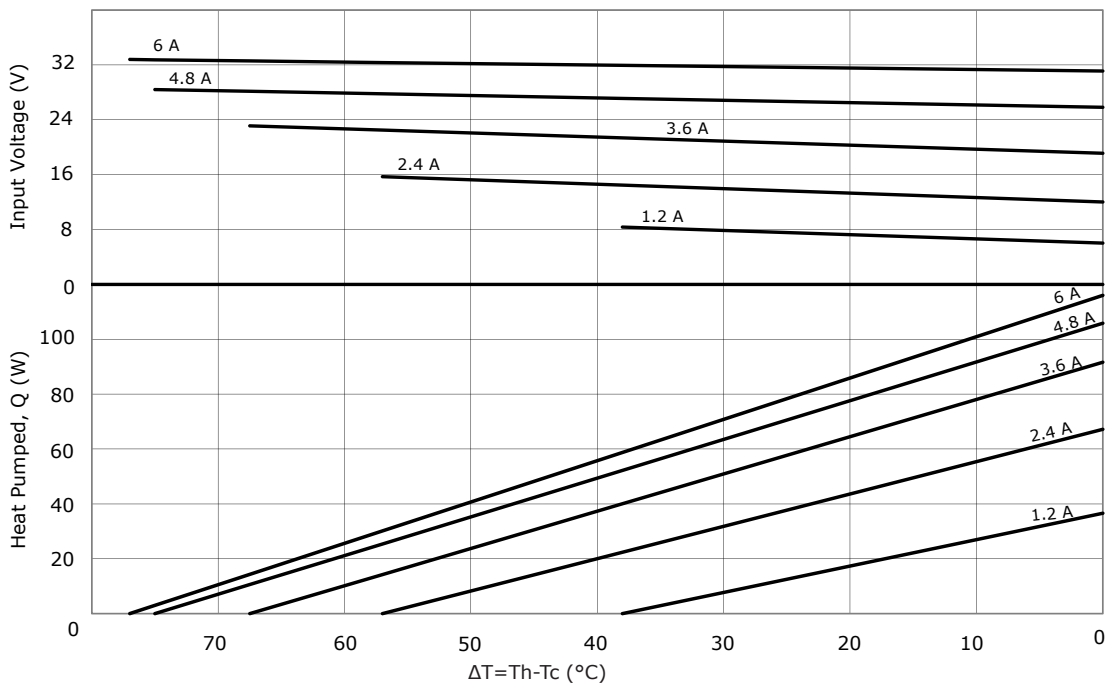

CP604060395 PERFORMANCE (Th=27°C)

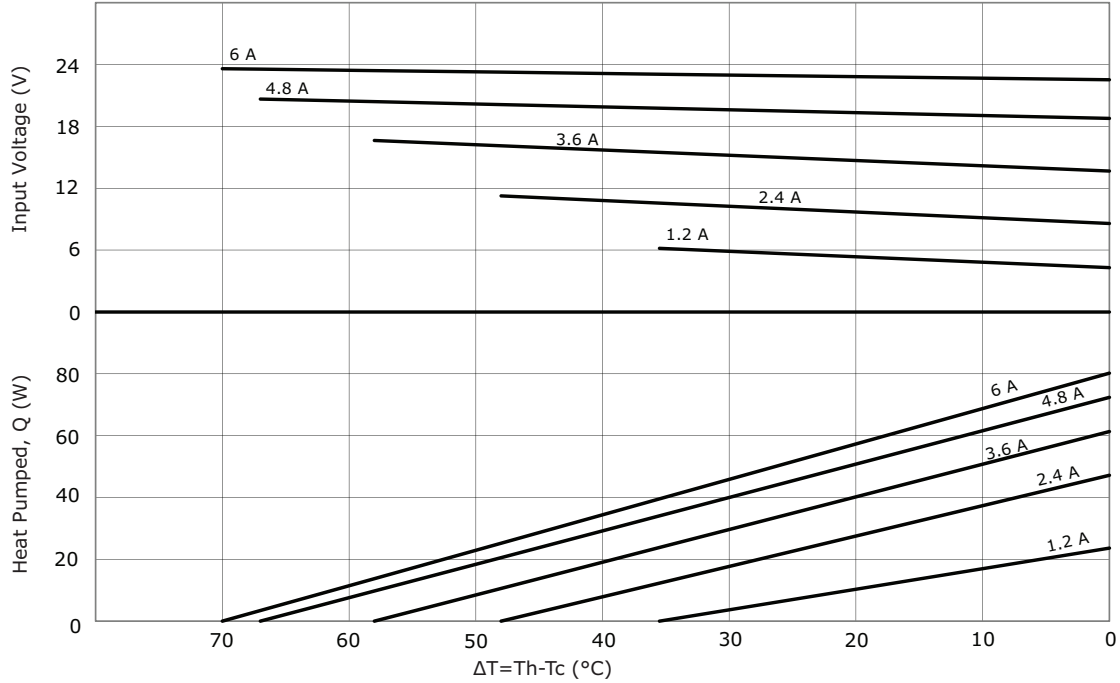

CP604060395 PERFORMANCE (Th=50°C)

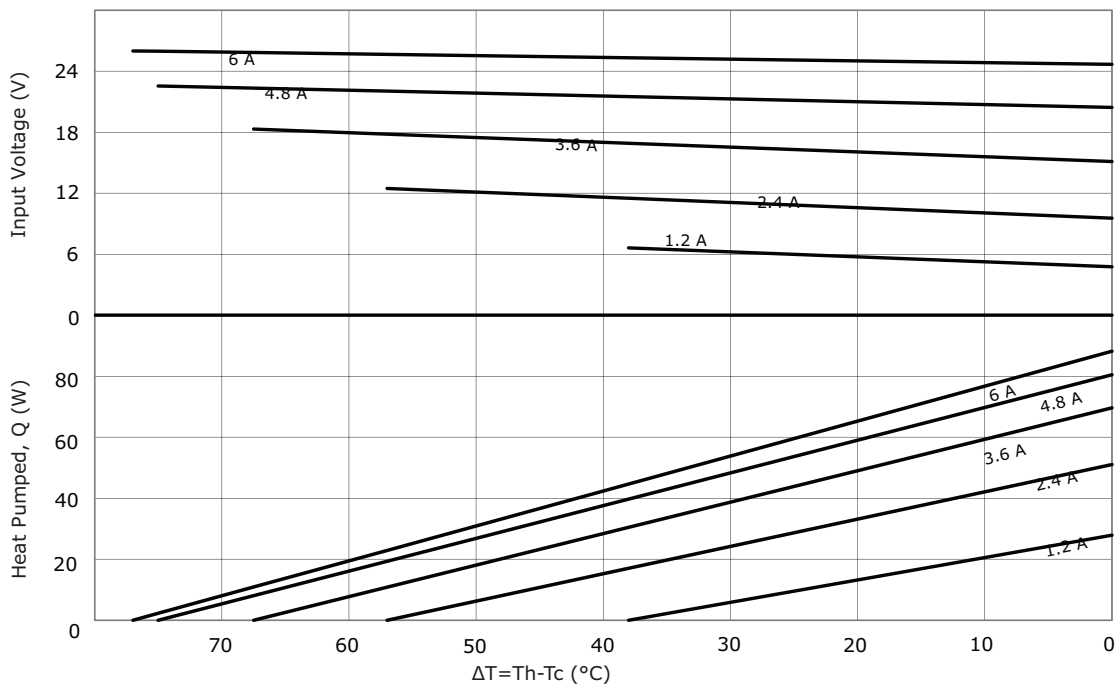

REVISION HISTORY

| rev. | description | date |
|------|--|------------|
| 1.0 | initial release | 09/08/2016 |
| 1.01 | updated datasheet | 09/25/2017 |
| 1.02 | added new models | 05/21/2018 |
| 1.03 | added models CP604060395, CP60555542, CP6030395, CP604040, CP6055354, CP60546241, brand update | 10/22/2019 |
| 1.04 | added model CP60302031H | 11/12/2020 |
| 1.05 | logo, datasheet style update | 08/05/2022 |
| 1.06 | CUI Devices rebranded to Same Sky | 09/12/2024 |

The revision history provided is for informational purposes only and is believed to be accurate.



Same Sky offers a one (1) year limited warranty. Complete warranty information is listed on our website.

Same Sky reserves the right to make changes to the product at any time without notice. Information provided by Same Sky is believed to be accurate and reliable. However, no responsibility is assumed by Same Sky for its use, nor for any infringements of patents or other rights of third parties which may result from its use.

Same Sky products are not authorized or warranted for use as critical components in equipment that requires an extremely high level of reliability. A critical component is any component of a life support device or system whose failure to perform can be reasonably expected to cause the failure of the life support device or system, or to affect its safety or effectiveness.

[sameskydevices.com](https://www.sameskydevices.com)