

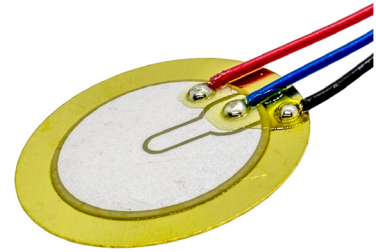

MODEL: CEB-27048-L100 | **DESCRIPTION:** PIEZOELECTRIC DIAPHRAGM

FEATURES

- 100 mm lead wire
- piezo element
- externally driven



SPECIFICATIONS

parameter	conditions/description	min	typ	max	units
operating voltage				30	Vp-p
resonant frequency	only for piezo element without wire	3,900	4,400	4,900	Hz
resonant impedance	only for piezo element without wire			300	Ω
electrostatic capacity	at 100 Hz	14,000	20,000	26,000	pF
dimensions	$\varnothing 27 \times 0.48$				mm
weight			2.0		g
material	brass				
terminal	wire leads				
operating temperature		-20		60	$^{\circ}\text{C}$
storage temperature		-20		70	$^{\circ}\text{C}$
hand soldering		360	370	380	$^{\circ}\text{C}$
RoHS	yes				

MECHANICAL DRAWING

units: mm

wire: UL1095 28 AWG

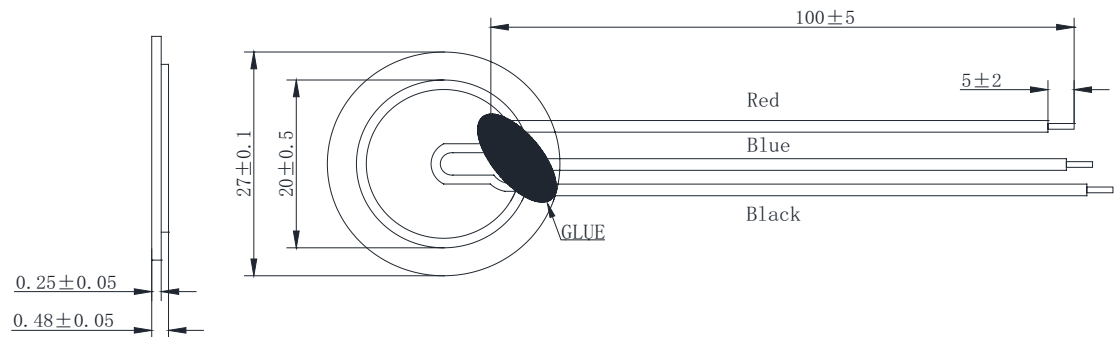

REVISION HISTORY

rev.	description	date
1.0	initial release	10/30/2024

The revision history provided is for informational purposes only and is believed to be accurate.



Same Sky offers a one (1) year limited warranty. Complete warranty information is listed on our website.

Same Sky reserves the right to make changes to the product at any time without notice. Information provided by Same Sky is believed to be accurate and reliable. However, no responsibility is assumed by Same Sky for its use, nor for any infringements of patents or other rights of third parties which may result from its use.

Same Sky products are not authorized or warranted for use as critical components in equipment that requires an extremely high level of reliability. A critical component is any component of a life support device or system whose failure to perform can be reasonably expected to cause the failure of the life support device or system, or to affect its safety or effectiveness.

[sameskydevices.com](https://www.sameskydevices.com)