

Product Change Notice (PCN)

Date: **04/26/2023**

PCN Number: **PCN-0454736R-01**

To Our Customers:

We appreciate your use of our products. Our commitment in maintaining and improving processes is demonstrated by plans to enhance our product quality, reliability, and manufacturability. The purpose of this notice is to inform you of a product change.

Product(s) Affected: *SJ2-2577X-SMT-TR Series.*

SJ2-25774B-SMT-TR, SJ2-25774A-SMT-TR & SJ2-25773B-SMT-TR

Reason(s) for Change: *Manufacturing process improvements*

Description of Change: *Minor Housing and footprint differences. Material Change on the housing and terminals. See image Below*

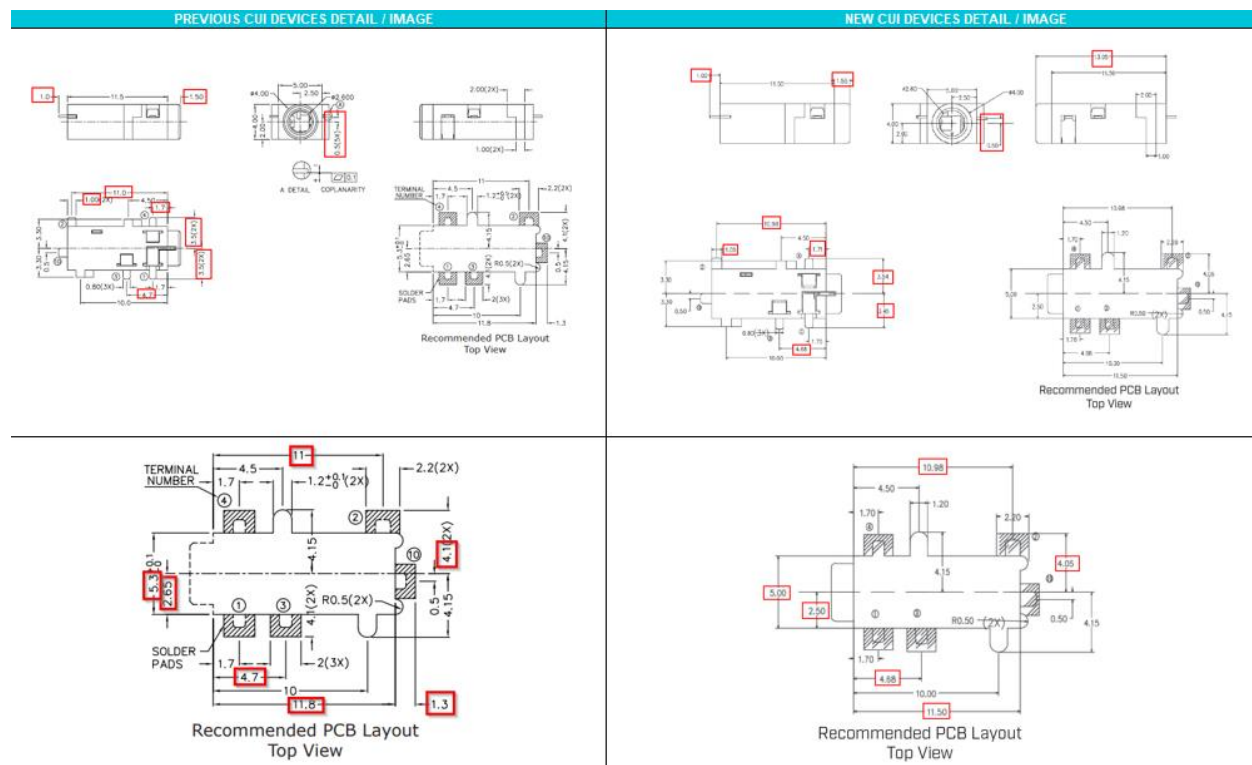

F-723-001

Revision: A

PREVIOUS CUI DEVICES DETAIL / IMAGE		
	MATERIAL	PLATING
terminal 1	copper alloy	silver
terminal 2	copper alloy	silver
terminal 3	copper alloy	silver
terminal 4	copper alloy	silver
terminal 10	brass	silver
plastic	PA10T	

NEW CUI DEVICES DETAIL / IMAGE		
DESCRIPTION	MATERIAL	PLATING/COLOR
terminal 1	brass	silver
terminal 2	brass	silver
terminal 3	brass	silver
terminal 4	brass	silver
terminal 10	brass	silver
housing	PA10T (UL94V-0)	black

SOLDERABILITY

parameter	conditions/description	min	typ	max	units
reflow storage	at relative humidity $\leq 50\%$			40	$^{\circ}\text{C}$
reflow soldering ¹	see reflow profile	255	260	265	$^{\circ}\text{C}$
drying conditions ²	parts in reel: bake at $40^{\circ}\text{C} \pm 5^{\circ}\text{C}$ for 72 hours parts removed from reel: bake at $40^{\circ}\text{C} \pm 5^{\circ}\text{C}$ for 10 hours				

Note:
 1. Must reflow solder within 72 hours from opening vacuum packaging at a temperature $\pm 20^{\circ}\text{C}$ & relative humidity $< 60\%$.
 2. When exceeding four lifts by > 72 hours.

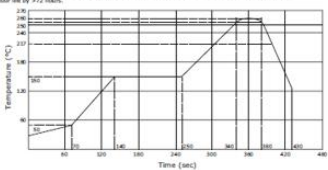

SOLDERABILITY

parameter	conditions/description	min	typ	max	units
reflow storage	$10-30^{\circ}\text{C}$, $< 50\%$ humidity				$^{\circ}\text{C}$
reflow soldering ¹	see reflow profile	255	260		$^{\circ}\text{C}$
drying conditions ²	parts in reel: bake at 110°C for 4 hours parts removed from reel: bake at 110°C for 4 hours				

Note:
 1. CUI Devices recommends to solder within 72 hours from opening vacuum packaging at a temperature $\pm 20^{\circ}\text{C}$ & relative humidity $< 60\%$.
 2. When exceeding four lifts by > 72 hours.

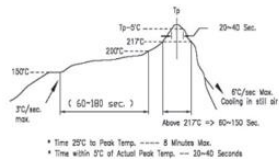

* Time 25°C to Peak Temp. --- 8 Minutes Max.
 * Time within 5°C of Actual Peak Temp. --- 10-40 Seconds

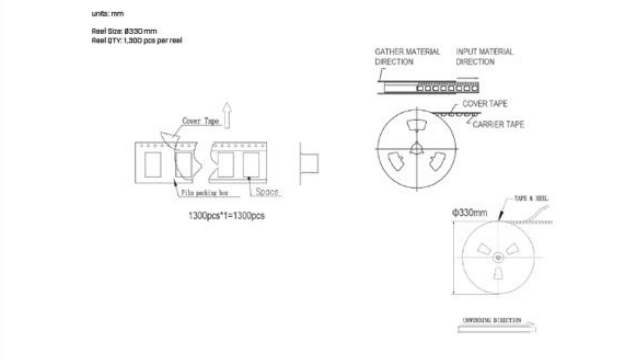
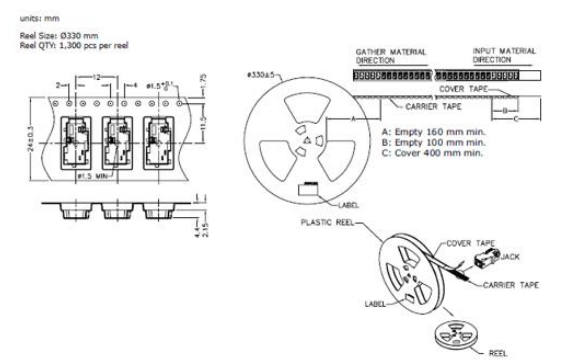



Affected Date Code: *04/24/2023*

Product Availability: *Pertaining to market availability*

PCN Approval:

Operations/Quality

A handwritten signature in black ink, appearing to read "Rae Adams", is written over a horizontal line.

Product Management

A handwritten signature in black ink, appearing to read "J. Adams", is written over a horizontal line.